

JVC



ENGLISH

DEUTSCH

FRANÇAIS

NEDERLANDS

HDD NAVIGATION/DVD RECEIVER FESTPLATTEN-NAVIGATIONSSYSTEM/DVD-RECEIVER SYSTÈME DE NAVIGATION À DISQUE DUR/RECEPTEUR DVD HDD NAVIGATIE/DVD-RECEIVER

KD-NX901

EXAD

NAVTEQ
ON BOARD

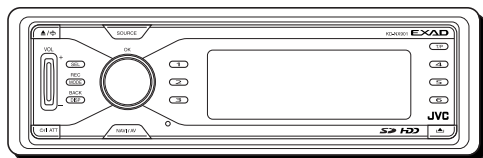
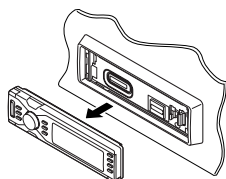

MP3
WMA



For cancelling the display demonstration, see page 14.
Zum Abbrechen der Displaydemonstration siehe Seite 14.
Pour annuler la démonstration des affichages, référez-vous à la page 14.
Zie bladzijde 14 voor het annuleren van de displaydemonstratie.

For installation and connections, refer to the separate manual.
Für den Einbau und die Anschlüsse siehe das eigenständige Handbuch.
Pour l'installation et les raccordements, se référer au manuel séparé.
Bijzonderheden over de installatie en aansluiting van het apparaat vindt u in de desbetreffende handleiding.

INSTRUCTIONS

BEDIENUNGSANLEITUNG
MANUEL D'INSTRUCTIONS
GEBRUIKSAANWIJZING

LVT1294-001B
[E]

Thank you for purchasing a JVC product.

Please read all instructions carefully before operation, to ensure your complete understanding and to obtain the best possible performance from the unit.

IMPORTANT FOR LASER PRODUCTS

1. CLASS 1 LASER PRODUCT
2. **CAUTION:** Do not open the top cover. There are no user serviceable parts inside the unit; leave all servicing to qualified service personnel.
3. **CAUTION:** Visible and invisible laser radiation when open and interlock failed or defeated. Avoid direct exposure to beam.
4. REPRODUCTION OF LABEL: CAUTION LABEL, PLACED OUTSIDE THE UNIT.

CAUTION - Visible and invisible laser radiation when open and interlock failed or defeated. AVOID DIRECT EXPOSURE TO BEAM.	ADVARSEL - Synlig og usynlig laserstråling når maskinen er åpen eller interlocken fejler. Undgå direkte eksponering til strålingen.	WARNING : Synlig och osynlig laserstrålning när den öppnas och spärrarna urkopplas. Beträkta laserstrålet. Undvik kontakt med strålen.	VARO - Avattassa ja suojalukitus ohjattuun tai valittuun olet alituna näkyväille ja näkymättömille lasersträloille. Vältä silmien kohdistamista suoraan lähteeseen.
---	--	---	--

Warning:

If you need to operate the receiver while driving, be sure to look ahead carefully or you may be involved in a traffic accident.

Caution

Never try to analyse or retrieve the data stored in the Hard Disk Drive (HDD). Otherwise, you may have your warranty invalid, and be penalized by law. The manufacturer assumes no liability for any damage resulting from such conduct as mentioned above.

For security reasons, a numbered ID card is provided with this receiver, and the same ID number is imprinted on the receiver's chassis. Keep the card in a safe place, as it will help the authorities to identify your receiver if stolen.

For safety....

- Do not raise the volume level too much, as this will block outside sounds, making driving dangerous.
- Stop the car before performing any complicated operations.

How to reset your unit

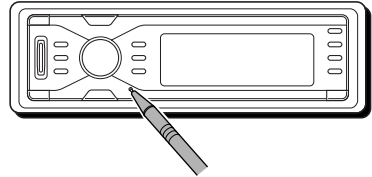

This will reset the microcomputer. Your preset adjustments will also be erased.

How to forcibly eject a disc

If a disc cannot be recognized by the receiver or cannot be ejected, ejects the disc as follows.

- While the source operation screen is shown...

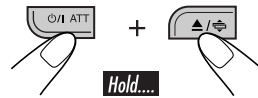

- If this does not work, try to reset your receiver.
- Be careful not to drop the disc when it ejects.

Temperature inside the car....

If you have parked the car for a long time in hot or cold weather, wait until the temperature in the car becomes normal before operating the unit.

WARNINGS

- **DO NOT** install any unit in locations where;
 - it may obstruct the steering wheel and gearchange lever operations, as this may result in a traffic accident.
 - it may obstruct the operation of safety devices such as air bags, as this may result in a fatal accident.
 - it may obstruct visibility.
- **DO NOT** operate the unit while manipulating the steering wheel, as this may result in a traffic accident.
- **The driver must not watch the monitor while driving.**

If the driver does it while driving, it may lead to carelessness and cause an accident.

- **If the parking brake is not engaged, the following messages appear...**
 - When you try to watch the playback picture on the monitor, **“DRIVER MUST NOT WATCH THE MONITOR WHILE DRIVING”** appears, and no playback picture will be shown.
 - When you try to enter your destination for the navigation guidance, **“Function not available while driving.”** appears, and you cannot enter the destination.

These warnings appear only when the parking brake wire is not connected, or the parking brake is not engaged (refer to the Installation/Connection Manual).

Caution on volume setting:

Discs produce very little noise compared with other sources. Lower the volume before playing a disc to avoid damaging the speakers by the sudden increase of the output level.

SAFETY INSTRUCTIONS

Use of the Navigation System is only permitted if the traffic conditions are suitable and you are absolutely sure that no risk, obstruction or inconvenience will be incurred to you, your passengers or other road users. The requirements of the Road Traffic Regulations must always be followed. **The destination must not be entered while driving the car.**

The Navigation System serves solely as an aid to navigation. It never releases the driver from his duties to drive carefully and to make own judgement in road traffic. Inaccurate or incorrect instructions may happen to be given due to changing traffic conditions. The actual road signs and traffic regulations must therefore always be observed. In particular, the Navigation System cannot be used as an aid to orientation when visibility is poor.

This Navigation System must only be used for its intended purpose. The volume of the car radio/Navigation System must be adjusted so that external noise is still audible.

When to update the database:

If the following message appears on the display when you turn on the power, visit <<http://www.jvc-exad.com>>. You can confirm the update information.

Your map data is more than one year old and updates may be available.

For more information:
<http://www.jvc-exad.com>

When replacing/rotating the tires:

It is required to clear all the accumulated learning data which is important for accurate navigation. To clear the data, perform “DELETE RUNTIME” on page 21.

Contents

How to reset your unit	2	Disc operations	48
How to forcibly eject a disc	2	Playing a disc in the receiver	48
How to read this manual	5	Basic operations	50
Introduction	6	DVD/VCD special functions	52
Remote controller		Selecting subtitles	52
— RM-RK230	8	Selecting audio languages	52
Main elements and features	8	Selecting multi-angle views	52
Control panel — KD-NX901	10	Disc menu operations	53
Parts identification	10	Zoom in	53
Preparations	11	On-screen disc operations	54
Getting started	13	On-screen bar basic operations	55
Basic operations	13	Control screen basic operations	57
Cancelling the display demonstration	14	List screen operations	58
Setting the clock	14	DVD setup menu	59
Navigation operations	15	Basic setting procedure	59
What is navigation	15	Other disc operations	62
Basic navigation operations	16	Basic operations	62
Navigation operation menus	17	Selecting the playback modes	64
Navigation setups	19	Changing the display information	65
Navigation setting menus	20	HDD operations	66
Basic navigation processes	22	Playing genre/album/track in the HDD	66
Entering your destination	23	Selecting the playback modes	68
• By address	23	Changing the display information	69
• By postal code	26	Playing playlists	70
• By town centre	27	Recording audio CDs	70
• By destination lists	28	Assigning the titles	72
• By points of interests (P.O.I.)	28	Editing the HDD contents	72
• By the coordinates	31	• Erasing a track/album/genre	73
Storing addresses and routes	32	• Moving a track/album	73
Convenient features using the stored routes ...	34	• Sorting an album/genre	74
Setting guidance options	36	• Creating/editing a playlist	75
Setting route options	37	• Erasing a playlist	75
Route guidance	38	• Duplicating a playlist	76
Display information during guidance	39	• Storing tree information into SD	77
Dynamic guidance	41	• Confirming the HDD contents	77
Radio operations	42	SD operations	78
Listening to the radio	42	Inserting the SD card	78
Storing stations in memory	43	Selecting the playback modes	81
Listening to a preset station	44	Changing display information	82
Changing the display information	44	Duplicating data into HDD	82
Searching for your favourite programme ...	45		
Using the standby receptions	46		
Tracking the same programme	47		

Sound adjustments 84
Selecting preset sound modes (EQ: equalizer).....84
 Storing your own sound adjustments..... 85
 Adjusting the sound basic settings..... 86

General settings — PSM 87
 Basic procedure 87
 Selecting the dimmer mode 90

Other main functions 91
 Assigning titles to the sources 91
 Changing the control panel angle 92
 Detaching the control panel 92

CD changer operations 93
Playing discs in the CD changer93
 Selecting the playback modes..... 96
 Changing the display information 97

External component operations... 98
Playing an external component98



DAB tuner operations 99
Listening to the DAB service.....99
 Storing DAB services in memory..... 100
 Tuning in to a preset DAB service 100
 Searching for your favorite programme ... 101
 Using the Standby Reception 101
 Tracking the same programme 102
 Changing the display information 102

Maintenance 103
Language codes 104
More about the functions 105
Troubleshooting 112
Specifications 118
END-USER TERMS..... 120

How to read this manual

The following methods are used to make the explanations simple and easy-to-understand:

- Some related tips and notes are explained in “More about the functions” (see pages 105 – 110).
- Button operations are mainly explained with the illustrations as follows:

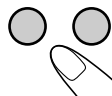
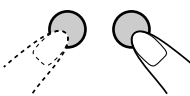
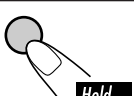
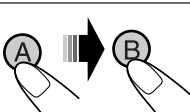
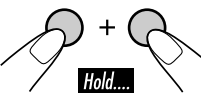
	Press briefly.
	Press repeatedly.
	Press either one.
	
	Press and hold until your desired response begins.
	Press (A), then press (B).
	Press and hold both buttons at the same time.

Introduction

DVD/CD player

Discs you can play

You can play back the following discs (12 cm and 8 cm) on this receiver:

- **DVD Video:** Recorded in PAL color system with Region Code “2” (see below).
 - DVD-R/DVD-RW recorded in the DVD-Video format can also be played.
- **Video CD (VCD)/audio CD**
- **MP3/WMA:** Recorded either in CD-R/CD-RW or DVD-R/DVD-RW/DVD-ROM.
 - CD-R/CD-RW: Compliant with ISO 9660 Level 1, ISO 9660 Level 2, Romeo, and Joliet.
 - DVD-R/DVD-RW/DVD-ROM: Compliant with UDF-Bridge Format.

Discs cannot be played back

DVD-Audio, DVD-ROM (data), DVD-RAM, DVD-R/DVD-RW recorded in the DVD-VR format, CD-ROM, CD-I (CD-I Ready), Photo CD, etc.

- Playing back these discs will generate noise and damage the speakers.

Note on Region Code:

DVD players and DVD Video discs have their own Region Code numbers. This receiver can only play back DVD discs whose Region Code numbers include “2.”

Examples:



“DVD Logo” is a trademark of DVD Format/Logo Licensing Corporation registered in the US, Japan and other countries.

Caution for DualDisc playback

- The Non-DVD side of a “DualDisc” does not comply with the “Compact Disc Digital Audio” standard. Therefore, the use of Non-DVD side of a DualDisc on this product may not be recommended.

Digital audio formats

The System can play back the following digital audio formats—Linear PCM/Dolby Digital*1/DTS*2/MPEG Audio.

- *1 *Manufactured under license from Dolby Laboratories. “Dolby” and the double-D symbol are trademarks of Dolby Laboratories.*
- *2 *“DTS” and “DTS 2.0 + Digital Out” are registered trademarks of Digital Theater Systems, Inc.*

Hard Disc Drive (HDD)

Installation

This unit has a built-in HDD, which is a device to read minute magnetic changes. The inside of the device is precision components, requiring you to notice the following when installing the unit:

Install the unit at a place where the following conditions are satisfied:

- Level, dry and neither too hot nor too cold—between 5°C and 35°C.
- At an altitude between –300 m below sea level and +3000 m above sea level.
- With adequate ventilation to prevent internal heat buildup in the unit.

Before using HDD

While the unit is turned on, the hard disk is constantly rotating at a high speed. This requires you to notice the following:

- DO NOT impart vibration or shock.
- DO NOT allow anything having strong magnetism or emitting strong electromagnetic waves (cellular phones, etc.) near the unit.
- DO NOT disconnect the power cords from the car battery when the unit is turned on. Failure in following the above cautions may damage the HDD (the stored data will be lost and be never restored).

Serial Copy Management System (SCMS)

This system uses SCMS which allows only first-generation digital copies to be made of premastered software such as regular CDs. If you try to record from a duplicated CD-R/RW, "SCMS Cannot Copy" may appear on the display then recording will be cancelled.

IMPORTANT: The manufacturer assumes no liability whatsoever for any damage resulting from missed opportunity or accidental erasure due to malfunctioning of the unit or due to trouble in the unit, such as fatal collapse of the hard disk drive itself.

- Since the HDD has its lifetime, it is strongly recommended to make a copy of your important recordings, and keep it using other recording devices.

It should be noted that it may be unlawful to re-record pre-recorded tapes, records, or discs without the consent of the owner of copyright in the sound or video recording, broadcast or cable programme and in any literary, dramatic, musical, or artistic work embodied therein.

Display indications

This unit displays a variety of the screens.

- More detailed information is described in each related sections.

Navigation displays:

- **Route guidance has not been started, but the unit is in navigation mode:**

The display shows the current position.



Compass is always shown even if "Compass" is set to "Off" (see page 88).

- **Route guidance has been started:**

The display shows the navigation guidance.

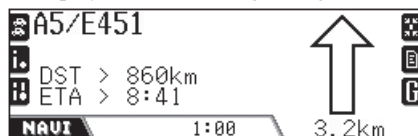

While the guidance is performed, you can also enjoy playing any source (ex. HDD).

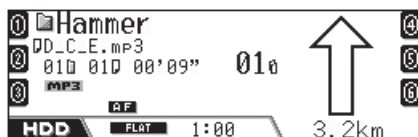

Source playback displays:

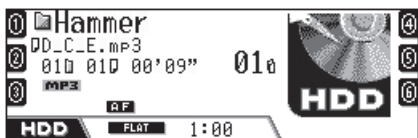

Compass is shown if "Compass" is set to "On."

Remote controller — RM-RK230

Installing the lithium coin battery (CR2025)

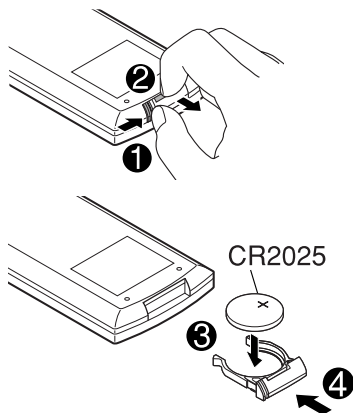

Using the remote controller:

- Aim the remote controller directly at the remote sensor on the unit (see page 10). Make sure there is no obstacle in between.
- Do not expose the remote sensor to strong light (direct sunlight or artificial lighting).

Warning:

- Do not install any battery other than CR2025 or its equivalent; otherwise, it may explode.
- Store the battery in a place where children cannot reach to avoid risk of accident.
- To prevent the battery from over-heating, cracking, or starting a fire:
 - Do not recharge, short, disassemble, or heat the battery or dispose of it in a fire.
 - Do not leave the battery with other metallic materials.
 - Do not poke the battery with tweezers or similar tools.
 - Wrap the battery with tape and insulate when throwing away or saving it.

Main elements and features

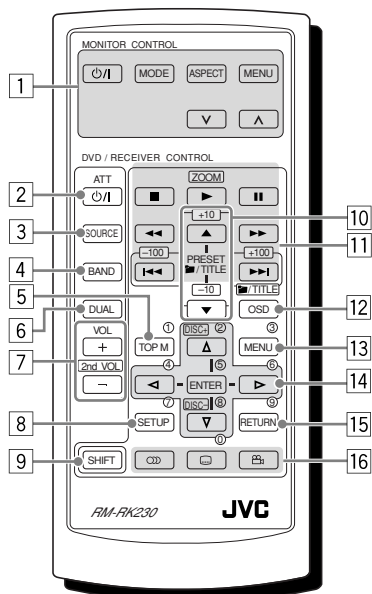

The remote controller can operate the playback sources any time, even when you are using the Navigation System.

MONITOR CONTROL

- 1 Monitor control buttons
 - Controllable only if your monitor is one of the JVC monitors—KV-MR9010 or KV-MH6510.

DVD/RECEIVER CONTROL

- 2 **⏻/⏪ ATT** (standby/on attenuator) button
 - Turns on and off the power and also attenuates the sound.
- 3 SOURCE button
 - Selects the source.
- 4 BAND button
 - Selects the FM/AM/DAB bands.
- 5 TOP M (menu) button*1
 - Displays the DVD disc menu.

- 6 DUAL button
- Does not function for this model.
- 7 VOL + / - buttons
- Adjusts the volume level.
 - Does not function as 2nd VOL +/- buttons for this model.
- 8 SETUP button*¹
- 9 SHIFT button
- 10 For disc operations:
- / TITLES / — Selects the titles (for DVD) or folders (for MP3/WMA, HDD, and SD). *²

For tuner operations:

- PRESET / — Changes the preset stations.

11 For disc operations:

- / (reverse skip/forward skip)*³
- / (reverse search/forward search): Not used for CD-CH, HDD, and SD.
- (stop), (play), (pause): Not used for CD-CH, HDD, and SD.
- (play) also functions as ZOOM button when pressed with SHIFT button.

For tuner operations:

- / — Searches for stations*³

- 12 OSD button
- Displays the on-screen bar.
 - Also functions as the button when pressed with SHIFT button.
 - You can directly select folders (for MP3/WMA) or titles (for DVD) using the number buttons (see the right column).
- 13 MENU button*¹
- Displays the DVD disc menu.
- 14 Menu operation buttons*¹
- Cursor (, , ,) , and ENTER
 - / : Also functions as DISC+ / - buttons when the source is “CD-CH.”
- 15 RETURN button*¹
- 16 DVD/VCD special function buttons
- (audio), (subtitle), (angle)

*¹ These buttons function as the number

buttons when pressed with SHIFT button.

*² These buttons function as +10/-10 buttons when pressed with SHIFT button.

*³ These buttons function as the +100/-100 buttons when pressed with SHIFT button.

How to select a number

- To select a number from 1 – 9:



- To select a number greater than 9:

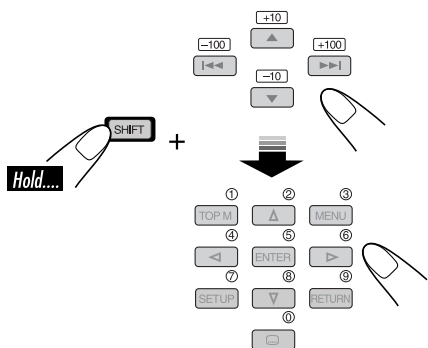

Ex:

To select 10, press +10, then 0.

To select 65, press +10 six times, then 5.

To select 104, press +100, 0 , then 4.

To select 236, press +100 twice, +10 three times, then 6.

- -100 and -10 buttons are used to correct a misentry. They reduce the corresponding digit number before entering the last digit number.

Parts identification

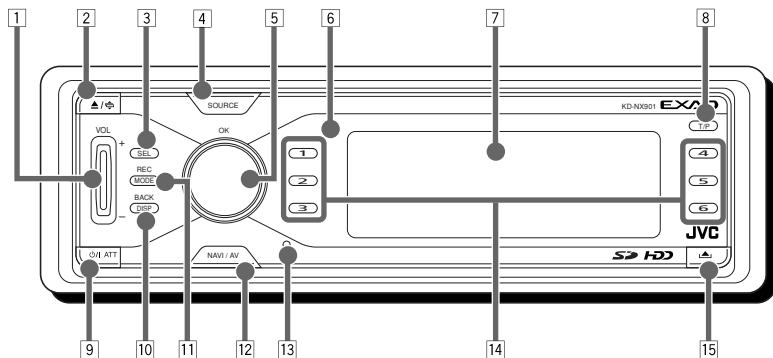

- 1 VOL (volume) +/- button**
- 2 ▲ / ⊘ (eject/angle) button**
 - Ejects the disc if pressed.
 - Changes the control panel angle if pressed repeatedly after held once.
- 3 SEL (select) button**
For Navigation System:
 - Displays the DESTINATION menu if pressed.
 - Displays the Setup Menu if pressed and held.
 For playback sources:
 - Displays the “Select Preset EQ” screen and sound setting screens if pressed repeatedly.
 - Displays the PSM menu if press and held.
- 4 SOURCE button**
- 5 Control dial/OK button**
 - Control dial: Selects the items.
 - OK button: Confirms the selection.
- 6 Remote sensor**
- 7 Display window**
- 8 T/P (traffic programme/programme type) button**
 - Turns on/off TA Standby Reception if pressed.
 - Turns on/off PTY Standby Reception if pressed and held.
 - Displays the traffic information while in the navigation mode.
- 9 P/I ATT (standby/on attenuator) button**
 - Turns on the power when it is off.
 - Attenuates the sound when the power is on.
 - Turns off the power if pressed and held.
- 10 DISP (display)/BACK button**
 - DISP: Changes the display patterns.
 - BACK: Goes back to the previous screen or cancels the setting while operating the menus.
- 11 MODE/REC button**
 - MODE: Changes the functions of some buttons.
 - REC: Activates the recording mode if pressed and held while playing a CD.
- 12 NAVI/AV button**
 - Switches the display information between navigation screen and source operation screen.
- 13 Reset button**
- 14 Number buttons**
- 15 (control panel release) button**

Preparations

Before using the Navigation System first time, it is required to calibrate the Navigation System.

- After deleting the run time (DELETE RUNTIME: see page 21) or changing the installation angle (UNIT ANGLE: see page 21), calibration is also required.

1



2

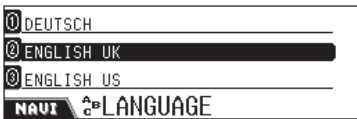
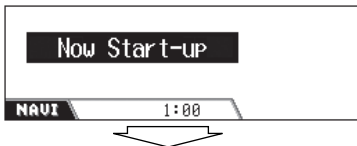
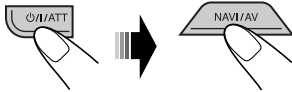

3

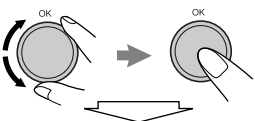
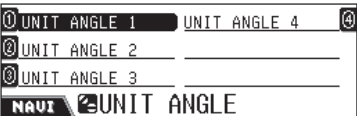
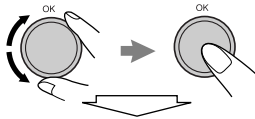

4

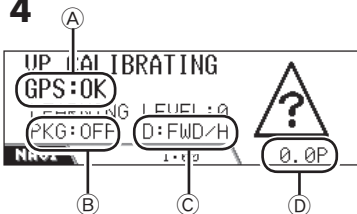

- 1 Turn on the ignition switch (either to ON or to ACC).
- 2 Press **O/I ATT** to turn on the power, then press **NAVI/AV**.
- 3 Select your preferred language and set your measured angle.
 - When shipped from the factory, navigation language is set to UK English.
 - See “Measuring the installation angle” on the Installation/Connection Manual (and also pages 20 and 21).
- 4 Confirm the following connections on the screen.

GPS antenna (A):

- GPS:OK → Connection is OK.
- GPS:NG → Antenna is disconnected or short-circuited.

Parking brake lead (B):

Step on the brake pedal, then disengage and engage the parking brake repeatedly.

- If “PKG:OFF” appears when disengaged and “PKG:ON” appears when engaged, connection is OK.

Reversing signal lead (C):

Engage the parking brake, step on the brake pedal, then shift the gearchange lever.

- If “D:FWD/H” and “D:FWD/L” alternate on the screen, connection is OK. (Only after calibration is started, “REV” appears when the gearchange lever is set to reverse.)

Speed signal lead (D):

Drive the car for a while.

- If the number increases as you speed up the car, connection is OK.

If connection is not good, check the connection.

To be continued....

5



Ⓔ



Ⓕ

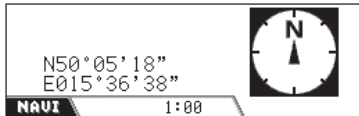

5 After confirming all the above connections, drive the car to start calibration.

- A certain speed is required for calibration.
- Calibration time differs among the cars.
- During calibrating, you can use the System as the receiver (you can listen to the music, etc.)
- If you turn off the ignition switch, calibration is temporarily stopped. When it is turned on, calibration will restart.

Once calibration is finished (when the learning level becomes “2”), the current position information appears on the display.

- Ⓔ: If you are on some road, the road name appears.
- Ⓕ: If not, the latitude/longitude appear.

Navigation (functions such as guidance) cannot be used until calibration is complete.

- “Function not available while driving.” appears if you try to enter the destination without the parking brake engaged (or without the parking brake lead connected). You cannot enter the destination.

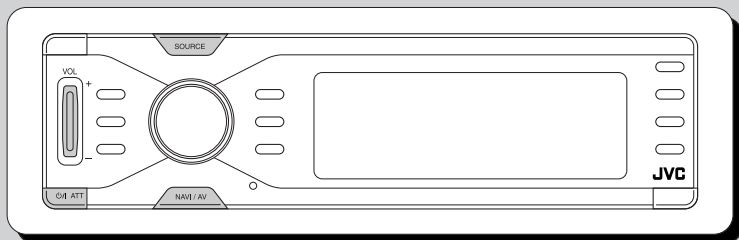

To use the Navigation System

- 1 Press the **O/I ATT** button.
- 2 Press the **NAV/AV** button. Each time you press the button, navigation and source screens alternate.

- 3 **Operate navigation.**
 Press the **SEL** button. See page 22.

- 1 **Set the destination.**
- 2 **Start guidance.**

To adjust the guidance volume level, see page 20.

While using the Navigation System, you can always confirm all available traffic information on the display.

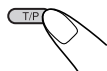

- For details, see page 41.

To enjoy source playback

- 1 Press the **O/I ATT** button.
- 2 Press the **SOURCE** button. You cannot select some sources if they are not ready.

- 3 Adjust the volume. **Volume 20**
- 4 **Operate the source as you like (for operations, see the respective pages).**

- 5 **Adjust the sound as you want. (See page 84.)**

To drop the volume in a moment (ATT)

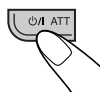

To restore the sound, press it again.

To turn off the power



Canceling the display demonstration

If no operations are done for about one minute, display demonstration starts (except when the Navigation System is in use).

[Initial: Interval]—see page 87.

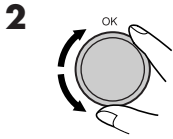

3 Select “Off.”

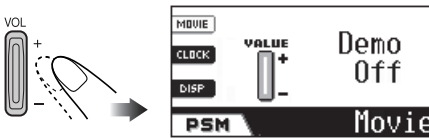

4 Finish the procedure.

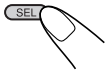

To activate the display demonstration

In step 3 above...

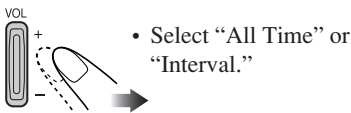

Setting the clock

The built-in clock is automatically adjusted by receiving the GPS signals. To obtain correct time information, it is required to set the local time.

- When the GPS signals are received first time after calibration (see page 11), the clock is automatically set to the Coordinated Universal Time (UTC).

Adjust the clock to your local time only after it has been set to UTC.



2 Select “24H/12H,” then select “24Hours” or “12Hours.”

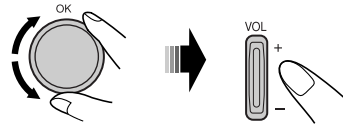

3 Select “Time,” then set the local time.

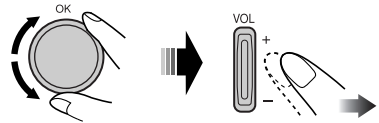

4 Finish the procedure.



To check the local time when the power is turned off

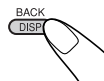

What is navigation

With the KD-NX901, the location of the car is determined via Global Positioning System (GPS), the distance from the desired destination and the required routes are determined using a digital road map, a navigation computer and sensors. A speedometer signal and a reverse signal are additionally used to calculate the estimated time of arrival or the remaining travel time to the destination.

For safety, navigation is predominantly in spoken form (in various languages, in female voice or in male voice) supported by a direction indicator on the display.

Safety instructions

- Traffic signs should be observed carefully while driving using the Navigation System. Navigation System is only an aid. Driver must always decide whether or not to heed the information provided. **JVC does not accept liability for erroneous data provided by the Navigation System.**
- Traffic guidance is restricted to passenger vehicles only. Special driving recommendations and regulations for other vehicles (e.g. commercial vehicles) are not included.
- **The destination cannot be entered while driving the car.**

Navigation guidance is performed, based on the database, therefore, it may not be applicable to the current situation because of changes in traffic conditions (e.g. changes in tollroads, principal roads, one-way traffic, or other traffic regulations). In this case, observe the current traffic signs or regulations.

Terms of licence

You are granted a non-exclusive licence to use the database for your personal purposes. The present licence does not authorise the granting of sublicenses.

Use of the data is only permitted in this specific JVC system. It is forbidden to extract or make further use of significant parts of the database content, or to duplicate, modify, adapt, translate, analyse, decompile or reverse-engineer any part thereof.

IMPORTANT for dynamic guidance

Once "TMC" (see page 37) is set to "✓ (On)," you can use dynamic route guidance. The traffic announcements sent by a TMC radio station is received and analysed. Navigation System can inform you of where congestion exists, and how you can detour it.

For the users in Austria:

The location and event code were made available by ASFINAG and BMVIT.

Basic navigation operations

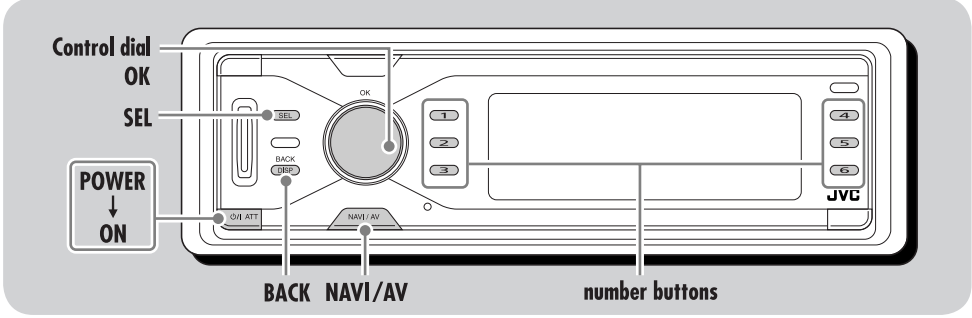

The following buttons are used for navigation operations.

To display the DESTINATION menu:



To select an item:



1 Select the number next to the item shown on the display.

- You can also select an item by...

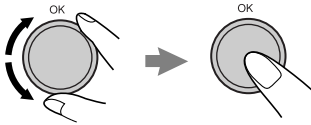

Select (reverse) the item, then confirm.

To return to the previous screens

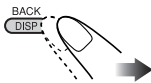

To enter a character:

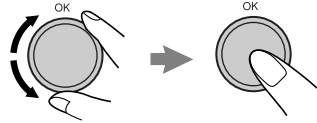

Select (reverse) a character, then enter.

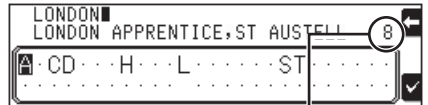

Number of items matching to the current entries

- Once you have entered a letter, the System can show only the letters to be entered as the next letter.
- The System will show a matching name closest to the current entries. If the correct location name is shown, press **6** to finish entry.
To show the list of the matching names, press and hold **OK**, then press the number buttons to select (or rotate the dial to show other lists).
- If no more letters can be entered, the System automatically completes the entry.
- To erase the misentry, press **4**.

To exit from navigation screens

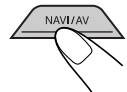

Navigation operation menus

Before operating navigation, be familiar with the operation menus and setup menus.

DESTINATION



This is the first menu displayed when pressing **SEL**.

- **SET DESTINATION:** Display the SET FROM menu—see page 22.
- **ROUTE OPTIONS:** Set your preferred settings to reach your destination such as availability of motorways, ferries, and tollroads—see page 37.



This menu appears after you have set your destination.

- **START GUIDANCE:** Start guidance to your destination—see page 22.
- **ADD VIA POINT:** Set a place where you want to stop by (Via Point) before reaching your final destination—see page 36. The SET FROM menu appears.
- **ITINERARY:** Confirm the destination where you are going to be navigated through Via Points.
- **ROUTE OPTIONS:** See page 37.

SET FROM



On this menu, you can select how to set your destination.

- **ADDRESS:** Set your destination by entering the address. The SELECT menu appears—see page 23.
- **PREVIOUS DEST.:** Set your destination by selecting from the last 50 guided destinations—see page 28.



- **PRESET ADDRESSES:** Set your destination by selecting from the six preset addresses—see page 28.



To preset a new address (and name the location)—see page 28.

- **STORED ADDRESSES:** Set your destination by selecting from 50 stored addresses—see page 28.



To store a new address (and name the location), see page 32.

- **P.O.I.:** Set your destination (or Via Point) by selecting from the P.O.I. (points of interests) list. It includes petrol stations, restaurants, hospitals, etc.—see page 28. P.O.I. functions differently according to navigation status.

SELECT

On this menu, you can select your particular destination by the country, city, street, town centre, postal code, and its coordinates.

- When you use navigation for the first time, only “COUNTRY” and “COORDINATES” are displayed.
- Once you have set “COUNTRY/CITY,” the previously set names are displayed.
- If the centres are listed for the currently displayed city, “CENTRE” is displayed.
- **COUNTRY:** Select the country where your destination exists—see page 24.

- **CITY:** Enter the city name of your destination—see page 24.

- **STREET:** Enter the street name of your destination—see page 25.

After you have entered the street name, you can select one of the options.

- **CENTRE:** Enter the town centre for your destination—see page 27.

- **POSTAL CODE:** Enter the postal code of your destination—see page 26.

After you have entered the postal code, you can enter the street name.

- **COORDINATES:** Enter the geographical coordinates (LATITUDE/LONGITUDE) to locate your destination—see page 31.

Navigation setups

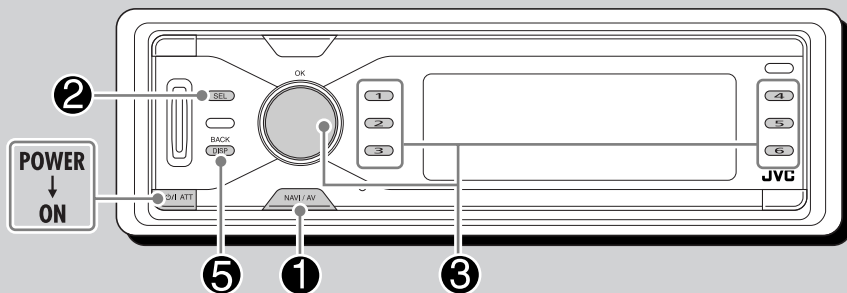

Before operating navigation, set up the Navigation System to your preference.

1 While listening to any source...

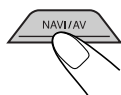

Navigation screen (current position)* appears.

* If navigation is already started, the guidance screen appears.



The numbers at the both sides are shown only after the preset addresses are stored (see page 33).

2 Display SETTINGS menu.

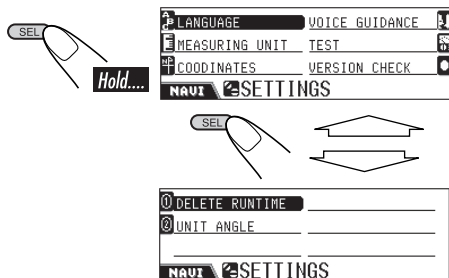

3 Change the setting.

1 Select the item to change.

- When selecting “VOICE GUIDANCE,” the submenu appears. Select an item again on submenu.

2 Select an option for the selected item.

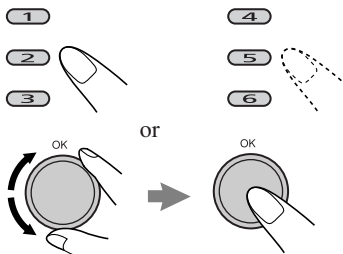

- To exit from the VOICE GUIDANCE submenu...

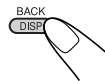

4 Repeat step 3 to set up other items.

5 Finish the setup.

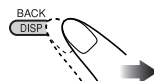

Navigation setting menus

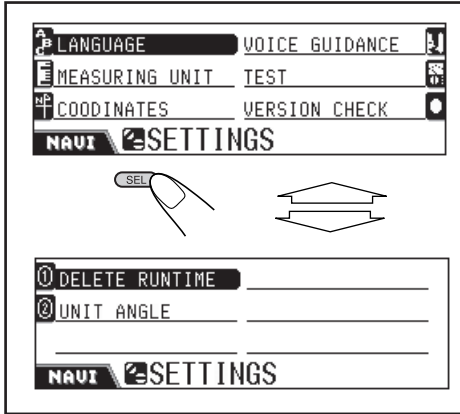

LANGUAGE

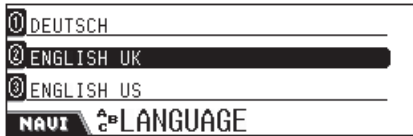

Set your preferred language:

DANSK, DEUTSCH, ENGLISH UK, ENGLISH US, ESPAÑOL, FRANÇAIS, ITALIANO, NEDERLANDS, SVENSKA

- Once you have selected the language, the selected language is used for navigation—spoken and displayed.

MEASURING UNIT



Set your preferred measuring unit:

METRIC (km), **IMPERIAL** (yard)

COORDINATES



Set your preferred unit:

DEG/MIN/SEC, DEG/MILLI/MICRO

VOICE GUIDANCE

Guidance voice comes out only through the front speakers (and the front line out on the rear).

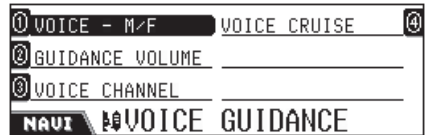

You can set up the following on this sub menu:

- **VOICE – M/F:** Select **MALE** or **FEMALE** voice for spoken navigation.
- **GUIDANCE VOLUME:** Adjust the guidance volume level—**0** to **8**.
- **VOICE CHANNEL:** Select the guidance output channel—**Lch ONLY**, **Rch ONLY**, or **Lch & Rch**.
- **VOICE CRUISE:** —**CRUISE: 0** (cancelled) to **CRUISE: 10**.

When this function is activated, the System automatically increases the guidance volume level as the car speeds up.

If you want to use the automatic volume increase even at low speeds, set the level to the lower numbers; on the other hand, if you want to use it only at high speeds, set it to the higher numbers.

TEST

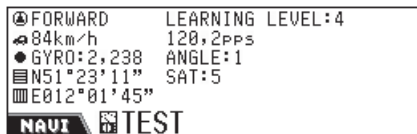

You can confirm the following of the current status:

- Direction/Learning level*1
- Velocity/PPS (Pulse Per Second)
- Gyro sensor/Unit angle
- Latitude/Number of GPS satellite received*2
- Longitude

*1 Indicates the learning data level. The higher the number is (the highest number is “4”), the more accurate the learning data is. (Learning data is the one the System accumulates for accurate navigation—such as velocity, Gyro output level with respect to car’s movement.)

*2 If “NG” is shown instead, the GPS antenna is not connected, or short-circuited.

VERSION CHECK

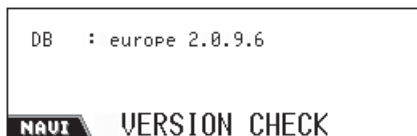

You can confirm the software version of the digital maps (DB).

DELETE RUNTIME

Reset the run time in the following cases:

- When you reinstall the unit to another car.
- When you replace or rotate the tires.



Once this is carried out, the learning data is cleared. When you exit from the navigation setting menu, the System will perform calibration internally again.

- If the guidance has been activated, you cannot use this function.

UNIT ANGLE

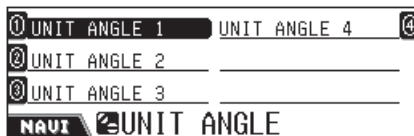

You can register the unit angle manually.

- Installation angle of the main unit is automatically required to be preset when you use the Navigation System for the first time after installation or when you delete run time.
- If the guidance has been activated, you cannot use this function.

Set one of the angles measured by the supplied gauge:

- **UNIT ANGLE 1:** Select when the installation angle is within the range of -5.0 to 17.0° .
- **UNIT ANGLE 2:** Select when the installation angle is within the range of 17.0 to 23.0°
- **UNIT ANGLE 3:** Select when the installation angle is within the range of 23.0 to 28.0° .
- **UNIT ANGLE 4:** Select when the installation angle is within the range of 28.0 to 32.0° . *

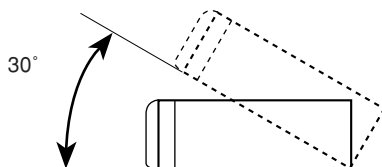

- * It is not recommended to install the main unit at an angle of more than 30° ; otherwise, the malfunction may result.

Basic navigation processes

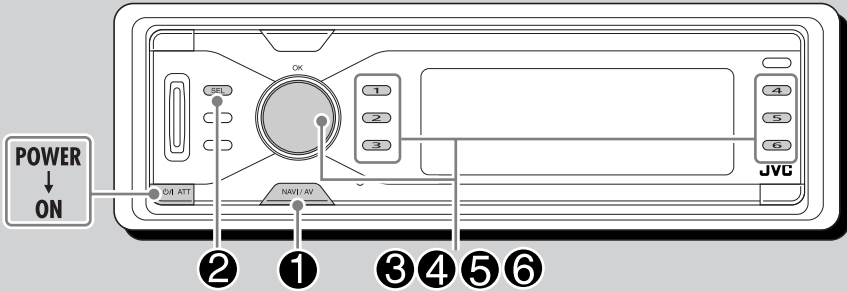

1 While listening to any source...
 Navigation screen (current position)* appears.



* If navigation is already started, the guidance screen appears.

2 Display the **DESTINATION** menu.

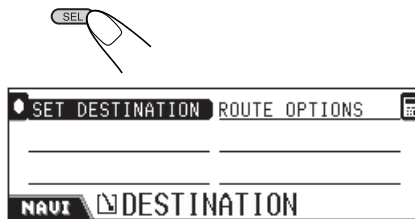

3 Select "SET DESTINATION."



4 Select one of the options listed on the display.

- **ADDRESS:** See page 23.
- **PREVIOUS DEST.:** See page 28.
- **PRESET ADDRESSES:** See page 28.
- **STORED ADDRESSES:** See page 28.
- **P.O.I.:** See page 28.
- You can also locate your destination by entering the coordinates (see page 31) and by selecting a stored route (see page 34).

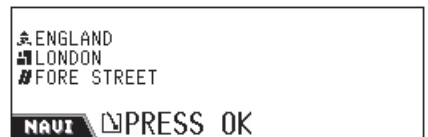

5 Confirm the selected destination.

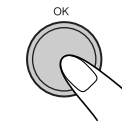

- Before (or after) starting guidance, you can set “ADD VIA POINT” and “ROUTE OPTIONS.”

3 Confirm the selected destination.



6 Select “START GUIDANCE.”

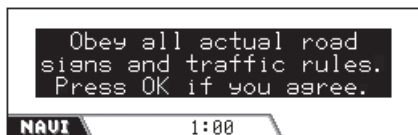

Entering your destination

By address

1 Display the DESTINATION menu.



2 Select “SET DESTINATION.”

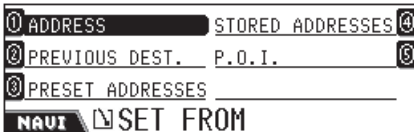

3 Select “ADDRESS.”

- When you use navigation for the first time, the following screen appears.



- Once you have used navigation, your last destination is shown.



7 Confirm.



Route is calculated, then guidance starts.

To cancel the route guidance...

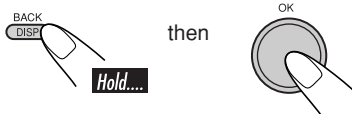

Starting navigation guidance to the preset addresses

Once you have stored the PRESET ADDRESSES (see page 33), starting guidance to the addresses is very simple and easy.

- If the navigation is already started, you cannot use this function.

1 While listening to any source...



Navigation screen (current position) appears.

2 Select the preset address number.

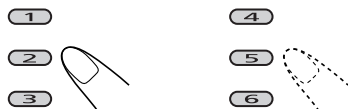

To be continued...

4 Locate your destination country.

- If the country name is shown in the “COUNTRY” column, select the country only when your destination is located in a different country.

1 Select “COUNTRY.”



2 Select your destination country.



5 Locate your destination city.

1 Select “CITY,” then enter the city name.



- If the city name is shown in the “CITY” column, select the city only when your destination is located in a different city.

Ex. Enter “LONDON.”

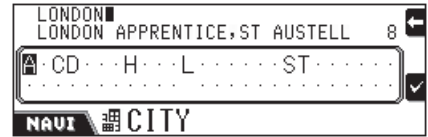
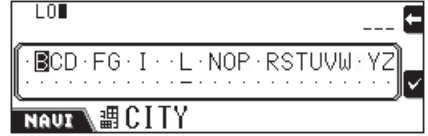
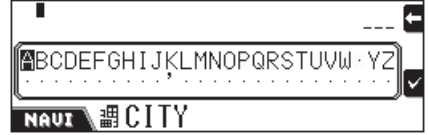

2 To select the city displayed on the 2nd line...

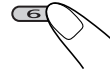

To display the list of the matching names, then select the city on the list...

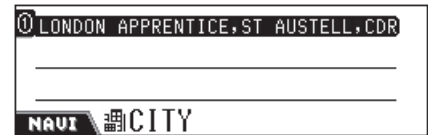
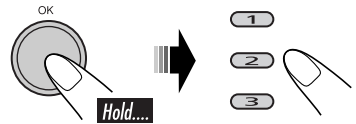

6 Locate your destination street in the selected city.

- 1 Select “STREET,” then enter the street name.

Ex. Enter “FORE.”

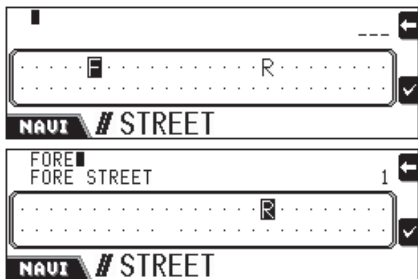

- To locate your destination by town centres, select “CENTRE” (see page 27).

- 2 To select the street displayed on the 2nd line...



To display the list of the matching names, then select the street on the list...

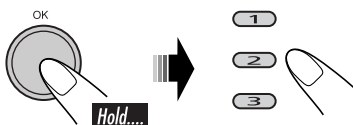

If the same name is used for different streets, STREET IN (area) entry menu appears. Enter the area where your destination street is located.



- 7 Select either “ENTIRE STREET,” “HOUSE NUMBER,” or “JUNCTION.”

- **ENTIRE STREET:** Select if you do not know the particular address.
- **HOUSE NUMBER:** Select if you know the exact address, then enter the house number. (If no data exist for the selected street, this will not be displayed.)
- **JUNCTION:** Select to display the list of the junctions, then select the junction nearest to your destination. (If no data exist for the selected street, this will not be displayed.)



- 8 Confirm your destination.



By postal code

You can locate your destination by postal code after you have set the country.

1 Display the SELECT menu.

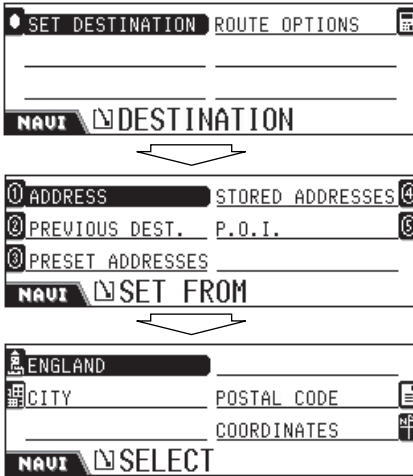

- If the destination country has not been set, set the country (see step 4 on page 24) before going the next step.

2 Set the postal code.

- 1 Select "POSTAL CODE."
- 2 Enter the postal code.

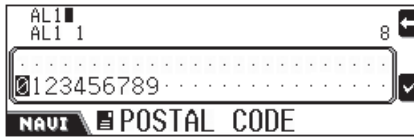

- 3 To select the postal code displayed on the 2nd line...

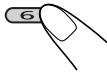

To display the list of the matching codes, then select the code on the list...

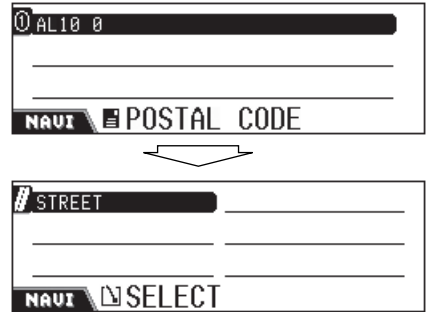
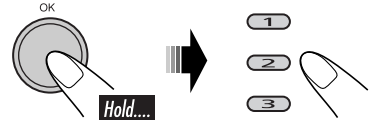

3 Follow steps 6 and 7 on page 25.





2 Select “CENTRE.”

Centre lists within the selected city appear.

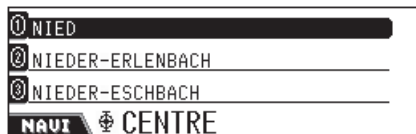

3 Select your destination centre.



4 Confirm your destination.



By town centre

You can locate your destination by town centre once you set the country and the city.

1 Display the SELECT menu.

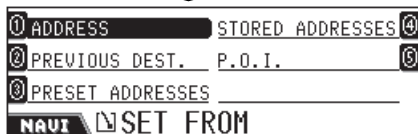

- If the city name has not been entered, “CENTRE” will not be used. ⇒ Enter the city name (see step **5** on page 24), then confirm your entry so that the following screen appears.



- If the data for the centres within the city does not exist, “CENTRE” will not be used. ⇒ Select another method to enter your destination.

■ By destination lists

You can locate your destination by selecting from the following lists—**PREVIOUS DEST./PRESET ADDRESSES/STORED ADDRESSES.**

1 Display the SET FROM menu.

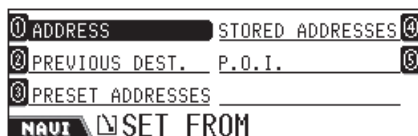

2 Select “PREVIOUS DEST.,” “PRESET ADDRESSES,” or “STORED ADDRESSES.”



Ex. when selecting “PREVIOUS DEST.”

3 Select one of the listed item.



4 Confirm your destination.



■ By points of interest (P.O.I.)

You can locate your destination by selecting from the P.O.I.

- To use the P.O.I., enter the country in advance; otherwise, the P.O.I. within the previous settings (country) will be located. (To set the country, see step 4 on page 24.)

1 Display the SET FROM menu.

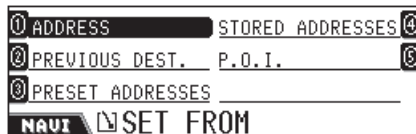

2 Select “P.O.I.”



- CATEGORY:** Select from the categorized locations.
- NAME:** Enter the name of your P.O.I. directly.
- AREA:** Select the area where you want to search for your P.O.I.
- TELEPHONE NUMBER:** Enter the telephone number of your P.O.I.
- Country (Ex. ENGLAND):** Change the country if necessary. ⇨ Select the country (see step 4 on page 24).
- If the country has not been selected, the country selection is automatically requested in this step.

Selecting P.O.I. by category

P.O.I. are categorized and sub-categorized for you to find easily.

3 Select "CATEGORY."

Main categories list appears.



4 Select the main category you want.

• Then, display the sub-categories...

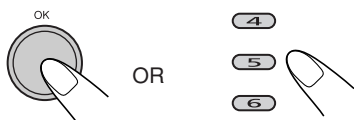

Sub-categories list of the main category selected appears. (Ex. when selecting SHOPPING for the main category). ⇨

Go to step 5.

• If you want to search for all the items in the main category...

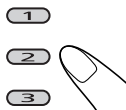

CITY entry menu appears. ⇨ Go to step 6.

5 Select the sub-category you want.

CITY entry menu appears.

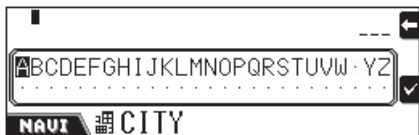

6 Enter the city within which you want to locate your P.O.I.

P.O.I. list appears.



7 Select (or confirm) your destination.



8 Confirm your destination.



Selecting P.O.I. by entering the name

3 Select "NAME."

P.O.I. name entry menu appears.

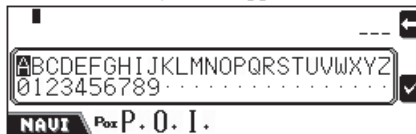

4 Enter the name of your P.O.I.

1 Enter the name.

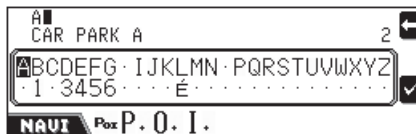

To be continued...

- 2 To select the name displayed on the 2nd line...



To display the list of the matching names, then select the name on the list...

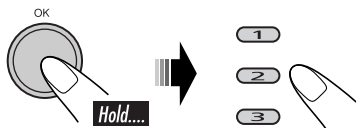

- If the name you have entered exists in many categories, P.O.I. CATEGORY menu appears. ⇒ Select the categories.
- If the name you have entered exists in many cites, CITY entry menu appears. ⇒ Enter the city.

5 Select (or confirm) your destination.



6 Confirm your destination.



Selecting P.O.I. by area

You can locate P.O.I. from the following areas.

- **LOCAL AREA:** Select P.O.I. within the distance of 5 km from the current position. (Selectable anytime)
- **NEAR DESTINATION:** Select P.O.I. within the distance of 5 km from your destination. (Selectable after setting the destination)
- **ALONG ROUTE:** Select P.O.I. within the distance of 2 km along the route. (Selectable after starting the guidance)

3 Select “AREA.”

P.O.I. AREA menu appears.

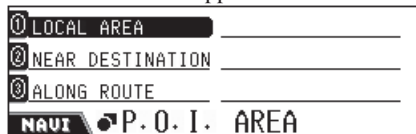

4 Select one of the options.

Main categories list appears.



5 Select the category you want.

- You can select your P.O.I. location either from the main category or sub-category (see page 29 for details).



6 Select (or confirm) your P.O.I.

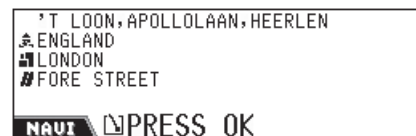

7 Confirm your destination.



Selecting P.O.I. by telephone number

3 Select “TELEPHONE NUMBER.”

Telephone number entry menu appears.

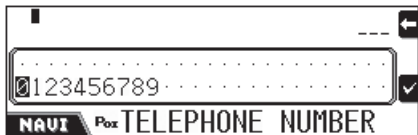

4 Enter telephone number (with its area code), then confirm the location.

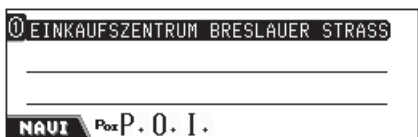

5 Confirm your destination.



■ By the coordinates

You can locate your destination by entering its latitude and longitude.

1 Display the SELECT menu.

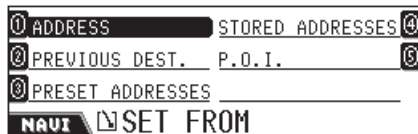

2 Select “COORDINATES.”

LATITUDE entry screen appears.

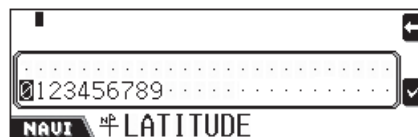

3 Enter the latitude, then select North (N) or South (S).

LONGITUDE entry screen appears.

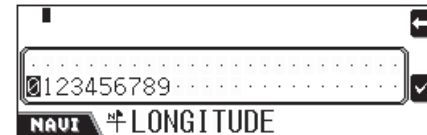

4 Enter the longitude, then select East (E) or West (W).

Geological position name of the entered position is displayed.

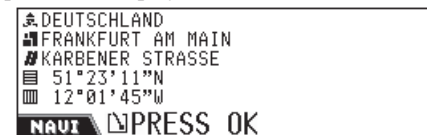

5 Confirm your destination.



Storing addresses and routes

You can store the addresses or routes in memory.

- To cancel editing during the process, press **BACK (DISP)**.

1 While the current position is shown...

- If navigation has been started, press **DISP (BACK)** to display the current position screen.

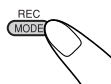

EDIT menu appears.

- SAVE ADDRESS:** Save addresses in memory.
- DELETE ADDRESS:** Delete memorized addresses.
- RECORD ROUTE:** Save the route in memory. By storing the routes, you can use the convenient features explained on page 34.
- DELETE ROUTE:** Delete memorized route.

Saving addresses in STORED ADDRESS

2 Select "SAVE ADDRESS."

SAVE AS menu appears.

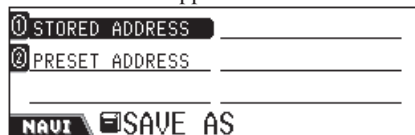

3 Select "STORED ADDRESS."

SAVE FROM menu appears.



- CURRENT ADDRESS:** Save the current address.
- ADDRESS:** Save a new address by setting it manually using the SELECT menu.
- PREVIOUS DEST.:** Save an address by selecting from the previous destinations.
- P.O.I.:** Save a P.O.I. using P.O.I. menus.

4 Select (or confirm) the address to store.

INPUT NAME menu appears.



5 Name the address.

- You can enter the maximum of 32 characters. For character entry method, see page 91.

6 Store the name.



EDIT menu appears again.

Saving addresses in PRESET ADDRESS

You can preset an address into each number buttons—total six addresses.

2 Select “SAVE ADDRESS.”

SAVE AS menu appears.

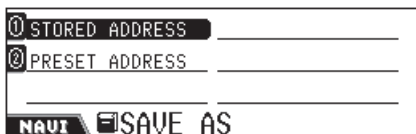

3 Select “PRESET ADDRESS.”

Stored addresses list appears.



4 Select the address to store from the list.

Preset addresses list appears.



5 Select the number you want to preset the address into.

INPUT NAME menu appears.



- If an address has been preset in the selected number, it will be overwritten.

6 Name the address.

- You can enter the maximum of 32 characters.

7 Store the name.



EDIT menu appears again.

If the preset addresses have been stored, you can directly select one by pressing the number buttons while the current position screen is shown.

Deleting memorized addresses

2 Select “DELETE ADDRESS.”

DELETE ADDRESS menu appears.



- **PREVIOUS DEST.:** Delete an unwanted address from the PREVIOUS DEST. list.
- **STORED ADDRESSES:** Delete an unwanted address from the STORED ADDRESSES list.
- **PRESET ADDRESSES:** Delete an unwanted address from the PRESET ADDRESSES list.

3 Select one of the options (listed above).

4 Select an unwanted address.

“DELETE: PRESS OK” appears.

5 Confirm.



EDIT menu appears again.

To be continued...

Saving new routes

You can save up to 20 routes in memory.

2 Select “RECORD ROUTE.”

START RECORDING menu appears.



3 Start recording the route from the current position.



4 Drive the car following the route as you want to record, then stop recording when you arrive at your destination.

INPUT NAME menu appears.



5 Name the address.

- You can enter the maximum of 32 characters. For character entry methods, see page 91.

6 Store the name.



EDIT menu appears again.

To cancel the recording...



- Recording will also be cancelled if you switch off the car ignition switch.

Deleting stored routes

2 Select “DELETE ROUTE.”

ROUTES menu appears.

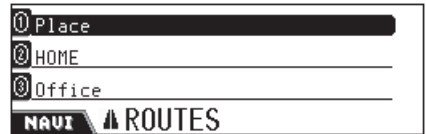

3 Select an unwanted route.



“DELETE: PRESS OK” screen appears.

4 Confirm.



EDIT menu appears again.

Convenient features using the stored routes

You can confirm your current position—distance to the destination and estimated time of arrival (ETA) if you are on at least one of the stored routes, and set the route end as the guidance destination.

- You can also display the traffic information along the stored routes.

Checking ETA and distance

1 While not using guidance...

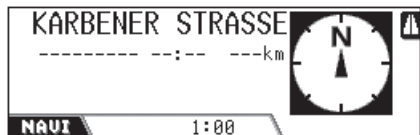
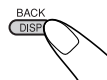

2

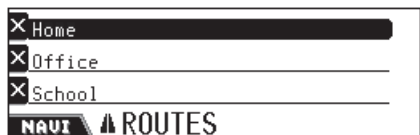

ROUTES menu appears.

3 Select the route you are now taking.

- You can select up to 3 routes in this step, so that you can know the current position on these route.

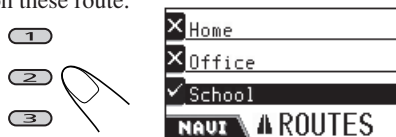

To move to another page of the list (if any), rotate the dial.



4 Display the information.

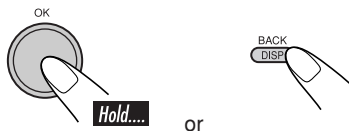

If you now press the number button corresponding the route number, you can set its route end as the guidance destination. (To start the guidance, see page 22).

Checking traffic information along the stored routes

If the number icon is highlighted on the display as in the example below, some traffic information is available along the route.

The display example below indicates that some traffic information is available along the stored route 1 (Home).



This means you are not on this route now.

To check the traffic information, follow the procedure below.

1 Select the stored route number (in this example, 1).

The list of the available information appears.



2 Select the one you want to confirm the information in details.

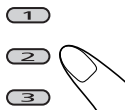

Setting guidance options

Entering the Via Points

You can set five Via Points along the way to your final destination.

- You can set Via Points even while you are navigated to your destination.

1 Enter your destination to display the following DESTINATION menu.



2 Select “ADD VIA POINT.”

SET FROM menu appears.



3 Set a Via Point using the above menu (and menus that follow).

- Operations are the same as explained for “Entering your destination.”

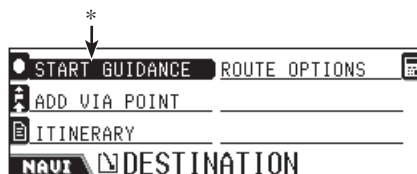

- * If you have already started guidance to the destination, “RESTART GUIDANCE” is shown.

4 Repeat steps 2 and 3 to set more Via Points.

Editing Via Point locations

1 Enter your destination to display the following DESTINATION menu.



2 Select “ITINERARY.”

ITINERARY list appears.



- Via Points are listed in sequence, and the final destination is at bottom.

3 To change the Via Point sequence

- Select a Via Point on the list, then press...

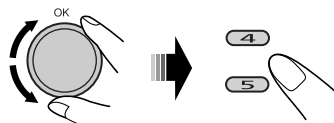

To erase a Via Point

- Select a Via Point on the list, then press...

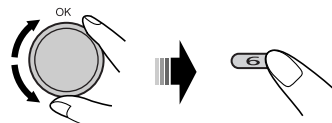

- You cannot delete the final destination once the guidance to it has been started.

4



Setting route options

- 1 Enter your destination to display the following **DESTINATION** menu.



- 2 Select “**ROUTE OPTIONS.**”

ROUTE OPTIONS menu appears.

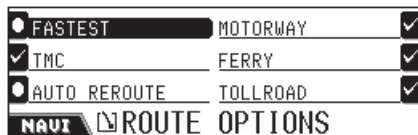

- 3 Set each option on the menu.

- For details on each option, see below.

4



ROUTE OPTIONS

On this menu, you can set some of the important elements of route calculation.

• **FASTEST (SHORTEST):**

FASTEST: The System calculates the shortest journey time.

SHORTEST: The System calculates the shortest route to the destination.

• **TMC:** Set the availability of Traffic Message Channel (TMC) information.

✓: The System calculates (and re-calculates whenever necessary) the route using TMC information. Dynamic guidance will become possible.

✗: The System calculates the route without using TMC information.

• **AUTO REROUTE/MANUAL REROUTE:**

Set how you want the System to reroute when it is required (for example, when some congestion is expected on the route—judged by received TMC information).

This function does not work when “TMC” is set to “× (Off).”

AUTO REROUTE: The System re-calculates the route whenever necessary.

MANUAL REROUTE: The System asks you whenever re-calculation is required (see example below).



- Press **OK** to detour. If not, press **BACK (DISP)**.

• **MOTORWAY:**

✓: The System calculates the route including the motorways.

✗: The System calculates the route excluding the motorways.

• **FERRY:**

✓: The System calculates the route including availability of ferries.

✗: The System calculates the route excluding availability of ferries.

• **TOLLROAD:**

✓: The System calculates the route including the tollroads.

✗: The System calculates the route excluding the tollroads.

Route guidance

Once you start guidance, you will hear the guidance in the selected language and voice. In addition to them, the display also shows the guidance information on the display.

- Guidance voice comes out only through the front speakers (and the front line out on the rear).

The guidance information appears.

- By pressing **NAVI/AV**, you can return to the playback source operation screen. Yet, the guidance information to the destination is displayed on the right of the display.

WARNING: Road traffic regulations always take priority when a vehicle is being driven in traffic. Navigation System is only an aid. Errors may occur in individual data items/entries. At all times, the driver must decide whether or not to heed the information provided.

JVC does not accept liability for erroneous data provided by the Navigation System.

The following are some of the example of the voice guidance (and display information):

- Display examples below are the ones used in the countries where the drivers should keep right.

- “When possible, U-turn.”

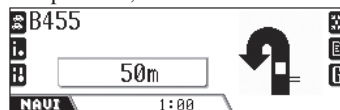

- “Right turn 400 meters ahead.”

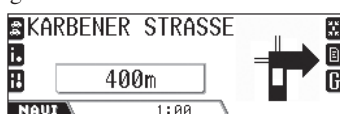

- “Take the first exit at the roundabout.”



- “Keep right 400 meters ahead.”

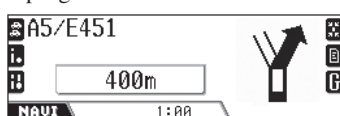

- “You have arrived at your destination. Guidance ends at this point.”

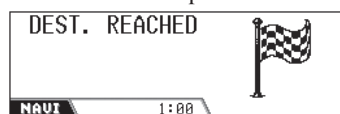

To return to the normal screen after reaching the destination, press any button.

- When you come close to a Via Point (approx. within 30 m), the following screen appears.



When you reach the Via Point, or move away (approx. 30 m) from it, the normal guidance screen will be resumed.

Display information during guidance

After starting guidance, the guidance information appears on the display.

- **When you are still far from the next turning point:**

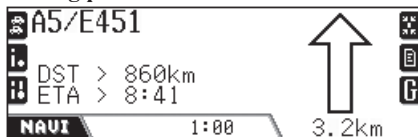

- The current road name *
- **DST:** Distance to the destination
- **ETA:** Estimated time of arrival

- **When you come close to the next turning point:**

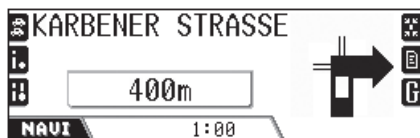

- The next road name * you will take
- The distance to the turning point

* If the road is unnamed in the database, "UNNAMED" appears for the road name.

While being navigated, you can use the following convenient functions using the number buttons.

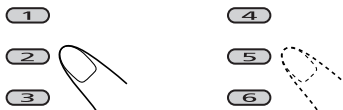

To return to the guidance screen (left) after you use these functions...

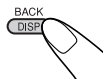

Avoiding congestion

When you realize a congestion exists ahead...

1

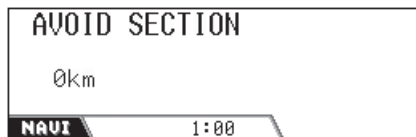
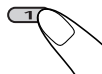

AVOID SECTION menu appears.

- 2 Enter the length of the congestion to avoid.

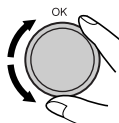

- 3 Start searching for the detour.



■ Displaying traffic information

You can confirm the traffic information of the place* nearest to your current position along the route.

* Within 100 km from the current position.

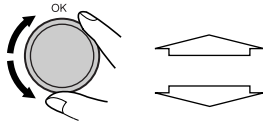
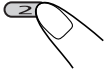

TRAFFIC INFO screen appears.

On this screen, you can confirm the following:

- **Event:** Shows the detailed traffic information. (If “-----” appears, no information is now available.)
- **Road:** on what road it is happening.
- **TAIL:** up to where it continues.
- **HEAD:** from where it is happening
- **Time:** The period for which this information is valid.

To confirm the available* traffic information along the route...

* Within 200 km from the current position.

1 Display the traffic information list.

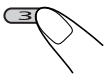

2 Select the one you want to confirm in details.

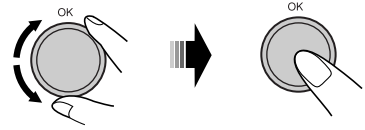

■ Displaying the current position in details

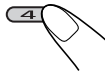

- 1st row: country
- 2nd row: city
- 3rd row: road
- 4th row: latitude
- 5th row: longitude

■ Displaying the turning points list

You can confirm the route you are taking to the destination.

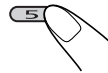

Displaying the guidance details



DETAILS menu appears.

Using this menu, you can confirm the following:

• JOURNEY INFO:

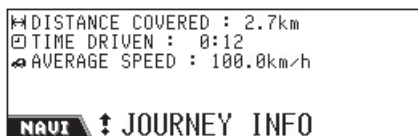

• DESTINATION INFO:



• GUIDANCE MODE:

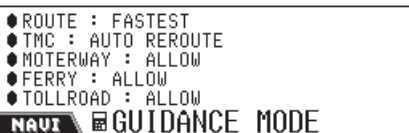

Dynamic guidance

Once “TMC” (see page 37) is set to “✓ (On),” you can use dynamic route guidance.

The traffic announcements sent by a TMC radio station is received and analysed by the System. The System can inform you of where congestion exists, and how you can detour it.

- Dynamic route guidance is not available in some countries.
- The System can receive TMC information without tuning in to such a station.

As the traffic announcements are transmitted by TMC radio stations, **JVC cannot assume responsibility for the completeness or accuracy of the announcements.**

To confirm all available traffic information...

You can confirm it any time except when the display is showing the playback source information.

1 Display the traffic information list.



2 Select the one you want to confirm in details.

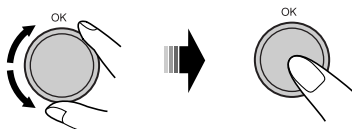

Radio operations

Listening to the radio

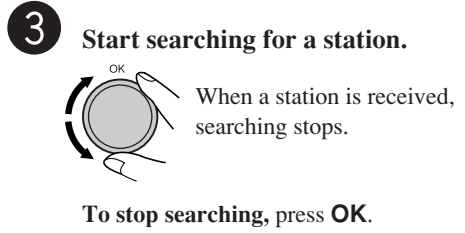
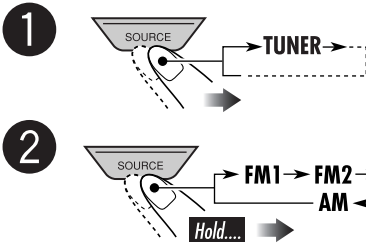
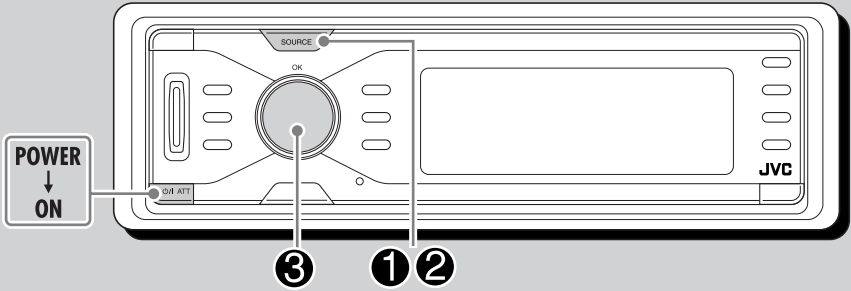

Lights up when receiving an FM stereo broadcast with sufficient signal strength.

To tune in to a station manually

In step 3...



1	FM/AM band
2	Station frequency
3	STEREO/MONO indicators
4	Station icon
5	PTY icon
6	TP indicator (see page 46)
7	PTY indicator (see page 47)
8	Sound mode (see page 85)
9	AF/REG indicator (see page 88)
10	Programme type (PTY: see page 45)
11	Station name (PS)
12	Preset number
13	DX/LOCAL indicators

When an FM stereo broadcast is hard to receive

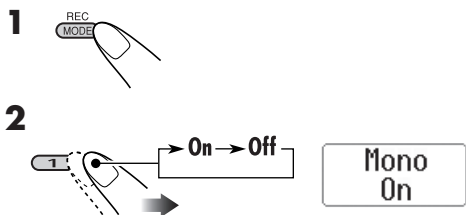

MONO indicator lights up.
Reception improves, but stereo effect will be lost.

To restore the stereo effect, repeat the same procedure. "Mono Off" appears and the MONO indicator goes off.

Tuning in FM stations only with strong signals

If received signals are weak, you may only hear noises. You can make this unit detect only stations with sufficient signal strength while searching for FM stations.

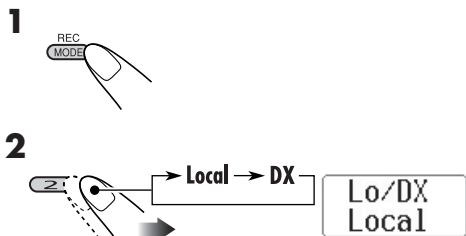

- **DX:** To tune in to all receivable stations. The DX indicator lights up.
- **Local:** To tune in to only stations with sufficient signal strength. LOCAL indicator lights up.

Storing stations in memory

You can preset six stations for each band.

FM station automatic presetting—SSM (Strong-station Sequential Memory)

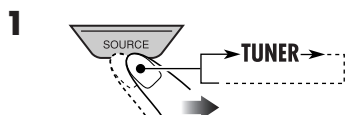

2 Select the FM band (FM1 – FM3) you want to store into.

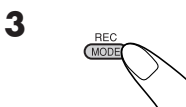

"SSM" appears, then disappears when automatic presetting is over.

Local FM stations with the strongest signals are searched and stored automatically in the FM band.

Manual presetting

Ex.: Storing FM station of 92.5 MHz into the preset number 4 of the FM1 band.

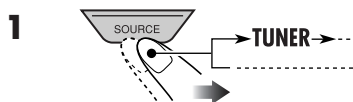

To be continued...

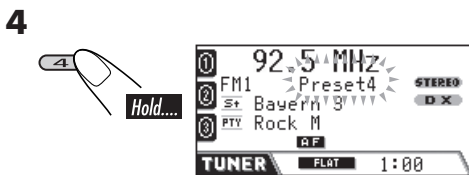
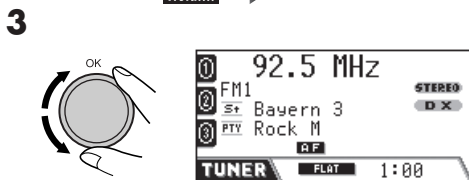
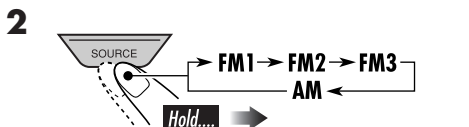

Preset number flashes for a while.

Listening to a preset station

- If you cannot tune in to the preset FM RDS station, Programme Search is working. For details, see “P-Search” on page 89.

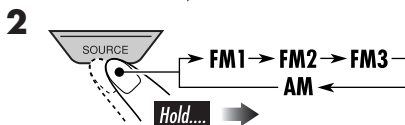
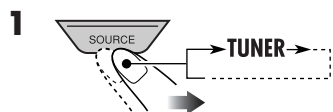

- 3** Select the preset station.

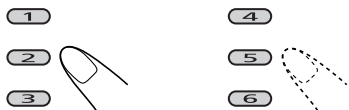

To select a preset station on the list

- 1** Select “TUNER,” then the band.

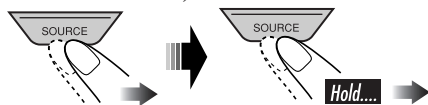

- 2** Display the preset station list.

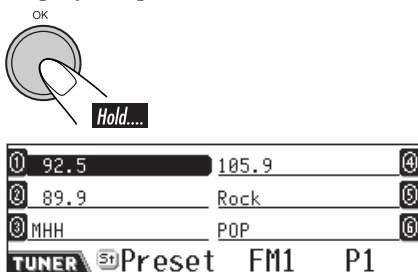

- For FM bands: Rotate the dial to display the lists for the other bands.

- 3** Select the preset station.

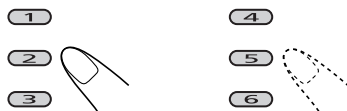

Changing the display information

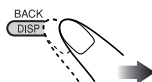

Station name is enlarged.

The following operations are only possible while you are tuning in to an FM RDS station.

What you can do with RDS

RDS (Radio Data System) allows FM stations to send an additional signal along with their regular programme signals.

By receiving the RDS data, this receiver can do the following:

- Programme Type (PTY) Search (see below)
- Standby Reception of Traffic Announcement (TA: see the following) or your favourite programme (PTY) (see pages 46 and 47)
- Tracking the same programme automatically —Network-Tracking Reception (see page 47)
- Programme Search (see page 89)

PTY codes

News, Affairs, Info, Sport, Educate, Drama, Culture, Science, Varied, Pop M (music), Rock M (music), Easy M (music), Light M (music), Classics, Other M (music), Weather, Finance, Children, Social, Religion, Phone In, Travel, Leisure, Jazz, Country, Nation M (music), Oldies, Folk M (music), Document

Searching for your favourite programme

You can tune in to a station broadcasting your favourite programme by searching for a PTY code.



The last selected PTY code appears.

2 Select one of your favourite programme type.

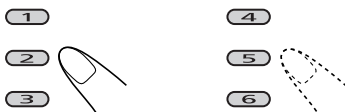

- To select from all PTY codes...

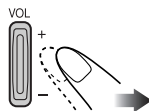

3 Start searching.



If there is a station broadcasting a programme of the same PTY code as you have selected, that station is tuned in.

To select a PTY code on the list

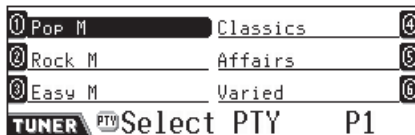
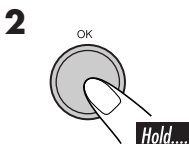
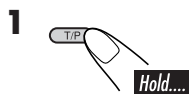

Preset PTY codes list (see page 46) appears.

- To move to the other lists...

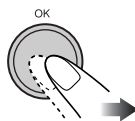

To be continued...

3 Select a PTY code.

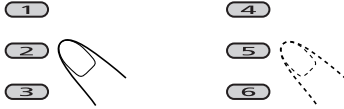

4 Start searching.



Storing your favourite programmes

You can store six favourite programme types.

Preset programme types in the number buttons (1 to 6):

1	2	3	4	5	6
Pop M	Rock M	Easy M	Classics	Affairs	Varied

1



2 Select a PTY code.



Ex.: When "Rock M" is selected

3 Select the preset number (1 – 6) you want to store into.



Preset number flashes for a while.

4 Repeat steps 2 and 3 to store other PTY codes into other preset numbers.

5 Finish the procedure.



Using the standby receptions

TA Standby Reception

TA Standby Reception allows the receiver to switch temporarily to Traffic Announcement (TA) from any source other than AM.

The volume changes to the preset TA volume level (see page 89).

- If the DAB tuner is connected, Standby Reception also works to search for a DAB service broadcasting Traffic Announcement.

To activate TA Standby Reception

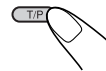

TP indicator either lights up or flashes.

- If the TP indicator lights up, TA Standby Reception is activated.
- If the TP indicator flashes, TA Standby Reception is not yet activated.

To activate TA Standby Reception, tune in to another station (or DAB service) providing the signals. The TP indicator will stop flashing and remain lit.

To deactivate the TA Standby Reception

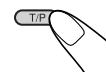

TP indicator goes off.

PTY Standby Reception

PTY Standby Reception allows the unit to switch temporarily to your favourite programme from any source other than AM.

- When shipped from the factory, “News” is selected for your favourite programme type. To change it to your favourite PTY code, see page 88.
- If the DAB tuner is connected, Standby Reception also works to search for a DAB service.

To activate PTY Standby Reception

1

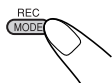

2

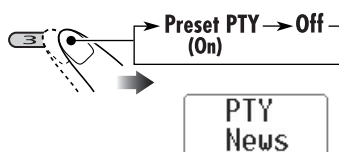

The PTY indicator either lights up or flashes.

- If the PTY indicator lights up, PTY Standby Reception is activated.
- If the PTY indicator flashes, PTY Standby Reception is not yet activated. To activate PTY Standby Reception, tune in to another station (or DAB service) providing the signals. The PTY indicator will stop flashing and remain lit.

To deactivate the PTY Standby Reception

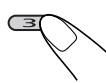
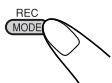

Select “PTY Off.”

PTY indicator goes off.

Tracking the same programme

When driving in an area where FM reception is not sufficient enough, this receiver automatically tunes in to another FM RDS station of the same network, possibly broadcasting the same programme with stronger signals (see the illustration below)—Networking-Track Reception.

When shipped from the factory, Network-Tracking Reception is activated.

To change the Network-Tracking Reception setting, see “AF-Regn'l” on page 88.

Programme A broadcasting on different frequency areas (01 – 05)

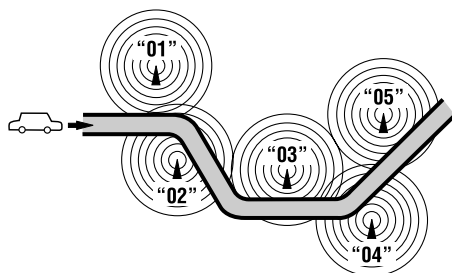

Disc operations

Playing a disc in the receiver

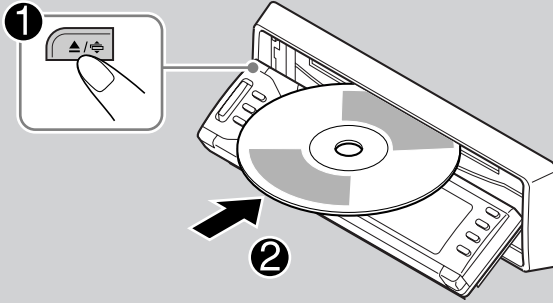

The disc type is automatically detected, and playback starts automatically (for DVD: automatic start depends on its internal program).

- Turn on the monitor for playing a DVD or VCD. You can also control the audio CD, CD Text, and MP3/WMA playback by referring to the monitor screen. (See pages 57 and 58.)

If the current disc is an audio CD, CD Text, MP3/WMA, or VCD without PBC, all tracks will be played repeatedly until you change the source or eject the disc.

- If a title list or disc menu appears while playing a DVD or VCD with PBC, see “Disc menu operations” on page 53.

The following marks are used to indicate the playable discs....

	
DVD Video	Video CD with PBC
	
Video CD (with/without PBC)	Audio CD/ CD Text
	
MP3/WMA disc	All discs listed here

Before performing any operations, make sure the following....

- For DVD playback, you can change the Setup Menu setting as you like. (See pages 59 – 61.)
- For DVD/CD playback, using the remote controller is more attractive. You can enjoy more functions.

When you want to operate the DVD/CD player using the buttons on the control panel, see “Other disc operations” on pages 62 to 65.

If “⊘” appears on the monitor when pressing a button, the disc cannot accept an operation you have tried to do.

- In some cases, without showing “⊘,” operations will not be accepted.

When you play back a multi-channel DVD software such as Dolby Digital and DTS, signals are down converted into 2 channels, and reproduced through the speakers and LINE OUT jacks on the rear. (See also “DOWN MIX” on page 61.)

- To fully enjoy multi-channel DVD software, connect a multi-channel decoder compatible with these sources to the DIGITAL OUT terminal on the rear. (See also “DIGITAL AUDIO OUTPUT” on page 61.)

While playing DVD:

1	Title number
2	Chapter number
3	Playing time information

While playing MP3/WMA discs:





















1	Folder name icon/Album title (Tag) icon
2	Folder number Track number Elapsed playing time
3	Track name icon/Track title (Tag) icon
4	MP3/WMA icon
5	Track title or track name
6	Album title/performer or folder name

While playing CD/VCD:

1 *	Disc title icon
2	Track number
3	Elapsed playing time
4 *	Track title icon
5 *	Track title
6 *	Disc title/performer or your assigned disc name
7	PBC playback (for VCD with PBC)

* Only for CD Text/Audio CD

Basic operations

Operations	Display indication and/or next operation
<p>To stop play temporarily</p>  	<p>“PAUSE” illuminates on the display. </p> <hr/> <p>A still picture appears.  </p> <p>Ⓐ Frame by frame playback</p>   <p>Ⓑ Slow motion playback</p>   <p>▶▶ : ▶ 1/32 ⇒ 1/16 ⇒ 1/8 ⇒ 1/4 ⇒ 1/2</p> <p>◀◀ : ◀ 1/32 ⇒ 1/16 ⇒ 1/8 ⇒ 1/4 ⇒ 1/2 *</p> <p>* Reverse slow motion playback is only for DVD.</p> <p>To resume normal play:</p>  
<p>To replay the previous scenes—One Touch Replay</p>  	<p>The playback position moves back about 10 seconds before the current position. </p>
<p>To stop playback</p>  	<p>When you start playback again, playback starts from where it has been stopped (Resume play).   </p> <hr/> <p>When you start playback again, playback starts from the beginning of the last track.  </p>

- During playback, on-screen guide icons appear on the monitor for a while (see page 111).

To eject the disc

To go to the next or previous chapters/tracks



- For DVD: During play or pause.
- For VCD: While PBC (see page 53) is not in use.

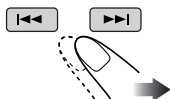

To fast-forward or reverse the track—Forward/Reverse Search

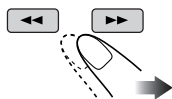

▶▶ : ▶▶ x2 ⇒ x5 ⇒ x10 ⇒ x20 ⇒ x60

◀◀ : ◀◀ x2 ⇒ x5 ⇒ x10 ⇒ x20 ⇒ x60

- You can also use the following buttons.

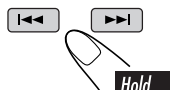

The search speed changes to x2 ⇒ x10.

To resume normal speed



To locate a particular title/chapter/track directly



- For DVD: During play or pause—Chapter Before playback—Title
- For VCD: While PBC (see page 53) is not in use.
- For MP3/WMA: Select a track within the same folder.



- To select a number greater than 9, see “How to select a number” on page 9.

To locate a title/folder



To locate a particular title/folder directly

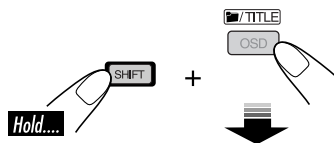

Then, within 10 seconds, press the number buttons (see page 9).

- For MP3/WMA discs: To directly select the folders using the number button(s), it is required that folders be assigned 2 digit numbers at the beginning of their folder names—01, 02, 03, and so on.

DVD/VCD special functions

Selecting subtitles

You can select the language of the subtitle to be shown on the monitor.

- You can also erase the subtitle if not necessary.

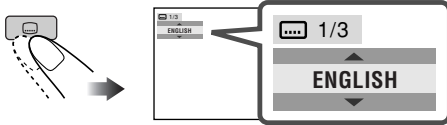

Ex. when the disc has 3 options

For VCD:

You can select the audio channel to play. (This is convenient when playing a Karaoke VCD.)

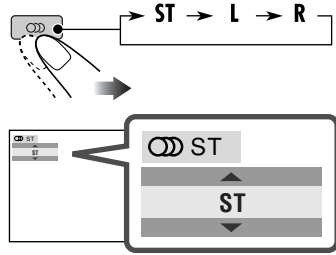

ST: To listen to normal stereo (left/right) playback.

L: To listen to the L (left) audio channel.

R: To listen to the R (right) audio channel.

Selecting audio languages

For DVD:

You can select the language to listen to if the disc has multiple audio languages.

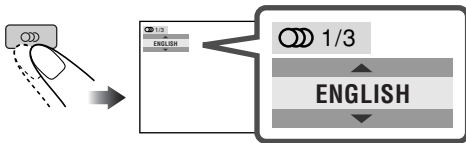

Ex. when the disc has 3 options

Selecting multi-angle views

You can view the same scene at different angles if the disc has multi-angle views.

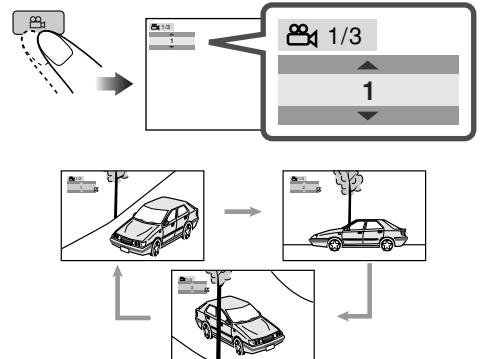

Ex. when the disc has 3 multi-angle views

Disc menu operations

Menu-driven playback is possible while playing back a DVD with menu-driven features or a VCD with PBC (PlayBack Control).

While playing a DVD



1

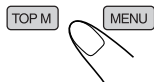

A title list or disc menu will appear on the monitor.

2 Select the item you want on the menu.

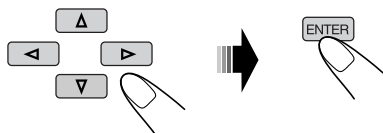

Selected item starts playback.

- On some discs, you can also select items using the corresponding number buttons.

While playing a VCD



- When a list of items is displayed on the monitor.

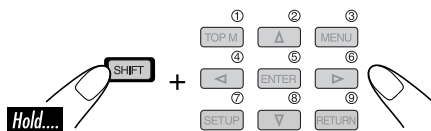

- To select a number greater than 9, see “How to select a number” on page 9.

To return to the previous menus

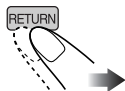

- For some discs, you can also move between the menus by pressing ◀◀ / ▶▶.

Canceling the PBC playback

1



2 Select a track number.

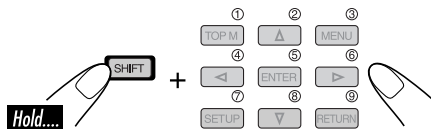

- To select a number greater than 9, see “How to select a number” on page 9.

To resume PBC

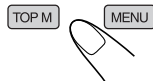

Zoom in

1

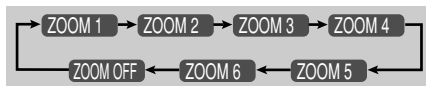
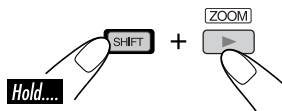

2 Move the zoomed-in portion.

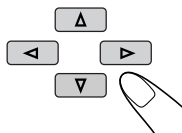

On-screen disc operations

About the On-Screen Bar

You can check the disc information and use some functions through the on-screen bar.

- For audio CD, CD Text, and MP3/WMA disc you can also use the control screen (see pages 57 and 58).

On-Screen bars



- 1 Disc type
- 2 • Audio signal format type (for DVD and DTS audio CD)
• PBC (only for VCD)
- 3 Playback information
 - T02-C03** Current title/chapter
 - TRACK 1** Current track
 - TOTAL** Elapsed playing time
 - T. REM** Remaining disc time (for VCD)
Remaining title time (for DVD)
 - TIME** Elapsed playing time of the current chapter/track
 - REM** Remaining time of the current chapter/track
- 4 Playback condition
 - Play
 - Forward/Reverse Search
 - Forward/Reverse Slow-motion
 - Pause
 - Stop
- 5 Operation icons
 - TIME** Time indication
 - Time Search *
 - TITLE** Title Search
 - CHAP** Chapter Search
 - TRACK** Track Search *
 - Change the audio language or audio channel.
 - Change the subtitle language.
 - Change the view angle.
 - Repeat play (for DVD)
 - REPEAT** Repeat play (for other discs) *
 - INTRO** Intro play *
 - RANDOM** Random play *

* Not available during PBC playback.

On-screen bar basic operations

1 Display the on-screen bar.

- For DVD/VCD:

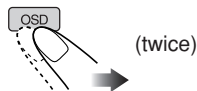

- For other discs:

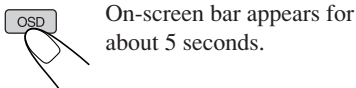

4 Finish the procedure.



To erase the on-screen bar



2 Select an item.

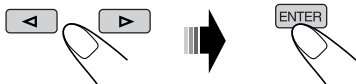

- If pop-up menu does not appear, pressing **ENTER** repeatedly changes the settings.
- If pop-up menu appears, go to steps **3** and **4**.



3 Make a selection from the pop-up menu.

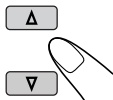

- Enter the number.

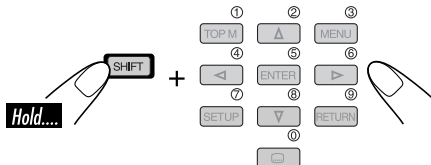

- The selectable options for Repeat/Intro/Random plays:

OFF Repeat play

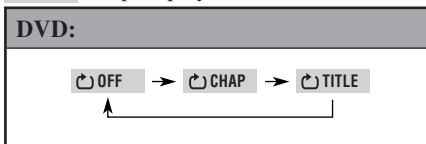

REPEAT Repeat play

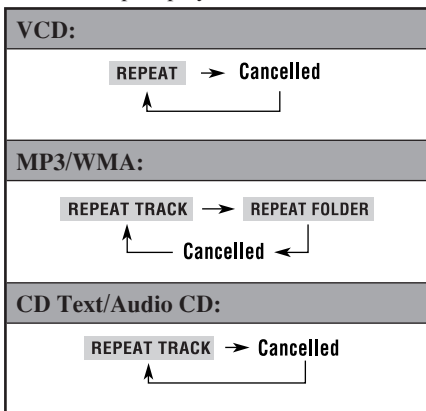

To be continued....

INTRO Intro play

VCD:	
INTRO	→ Cancelled
↑	
MP3/WMA:	
INTRO TRACK	→ INTRO FOLDER
↑	Cancelled ←
CD Text/Audio CD:	
INTRO TRACK	→ Cancelled
↑	

RANDOM Random play

VCD:	
RANDOM	→ Cancelled
↑	
MP3/WMA:	
RANDOM FOLDER	→ RANDOM DISC
↑	Cancelled ←
CD Text/Audio CD:	
RANDOM DISC	→ Cancelled
↑	

To change the time information

- 1 Select **TIME**.
- 2 Change the time information.

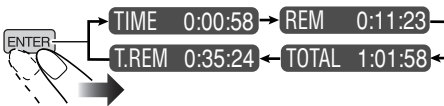

To search for a particular point by playing time

- 1 Select **⏪**.
- 2 Enter the elapsed playing time of the current title or of the disc.

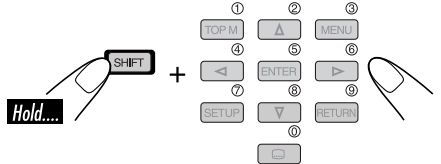

- Ex. • To enter 1 (hours): 02 (minutes): 00 (seconds), press 1, 0, 2, 0, then 0.
- To enter 54 (minutes): 00 (seconds), press 0, 5, 4, 0, then 0.
- It is always required to enter the hour digit (even "0" hour), but it is not required to enter trailing zeros (the last two digits in the examples above).
- To correct a misentry, press...



- 3 Finish the procedure.

To search for a particular title/chapter/track

- 1 Select **TITLE**, **CHAP** or **TRACK**.
- 2 Enter the number.

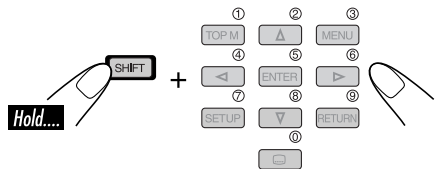

- To correct a misentry, press the number button until the correct number is entered.

- 3 Finish the procedure.

Control screen basic operations

You can search for and play the desired items through the control screen.

- The control screen automatically appears on the monitor when you insert a disc.

MP3/WMA control screen

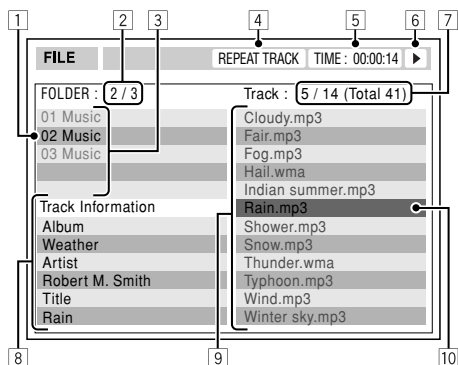

- Current folder
- Current folder number/total folder number
- Folder list
- Selected playback mode
- Elapsed playing time of the current track
- Operation mode icon
- Current track number/total number of tracks in the current folder (total number of tracks in the disc)
- Track information
- Track list
- Current track (highlighted bar)

To select a folder or track

- Select "Folder" list or "Track" list on the control screen.

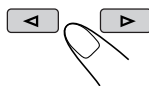

- Select a folder or track.

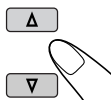

CD Text/Audio CD control screen



- While recording a CD into the HDD, CD Text/Audio CD control screen is not displayed.

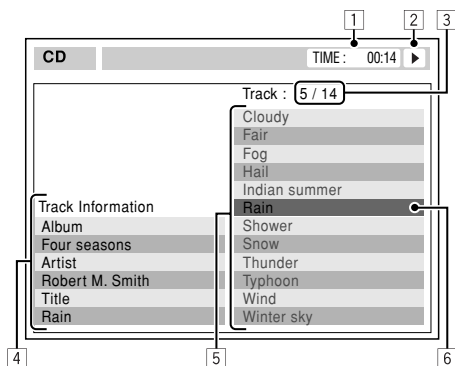

- Elapsed playing time of the current track
- Operation mode icon
- Current track number/total number of tracks
- Track information
- Track list
- Current track (highlighted bar)

To select a track

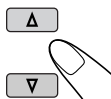

List screen operations

You can display the folder list/track list while playback is stopped. On this list, you can confirm the contents and start playback.

Folder/track list screens



Folder list (MP3/WMA)

1	2	3	
Folder : 153/440 Track 154/198 Page : 4/11			
fol130	fol140	fol150	fol160
fol131	fol141	fol151	fol161
fol132	fol142	fol152	fol162
fol133	fol143	fol153	fol163
fol134	fol144	fol154	fol164
fol135	fol145	fol155	fol165
fol136	fol146	fol156	fol166
fol137	fol147	fol157	fol167
fol138	fol148	fol158	fol168
fol139	fol149	fol159	fol169
			4

Track list (MP3/WMA/CD Text/Audio CD)

1	2	3	
Folder : 169/220 Track 154/198 Page : 4/11			
file0131.mp3	file0141.mp3	file0151.wma	file0161.wma
file0132.mp3	file0142.mp3	file0152.mp3	file0162.mp3
file0133.wma	file0143.mp3	file0153.wma	file0163.wma
file0134.mp3	file0144.mp3	file0154.mp3	file0164.mp3
file0135.mp3	file0145.wma	file0155.mp3	file0165.wma
file0136.wma	file0146.mp3	file0156.mp3	file0166.wma
file0137.wma	file0147.wma	file0157.mp3	file0167.wma
file0138.mp3	file0148.mp3	file0158.wma	file0168.wma
file0139.mp3	file0149.wma	file0159.wma	file0169.mp3
file0140.wma	file0150.wma	file0160.wma	file0170.wma
			4

Ex. Track list for MP3/WMA

- 1 Current folder number/total folder number (only for MP3/WMA)
- 2 Current track number/total number of tracks in the current folder (for MP3/WMA) or in the disc (for CD Text/Audio CD)
- 3 Current page/total number of the pages included in the list
- 4 Current folder/track (highlighted bar)

For MP3/WMA:

1 Display the folder list.



Each time you press the button, the list screen comes on and goes off.

2 Select the folder on the list.

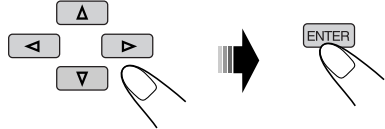

Track list of the selected folder appears.

3 Select the track on the list, and start playback.

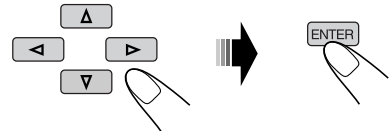

To go back to the folder list, press...



For CD Text/Audio CD:

1 Display the track list.



Each time you press the button, the list screen comes on and goes off.

2 Select the track on the list, and start playback.

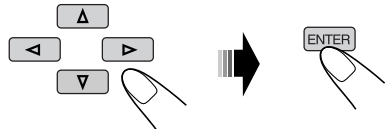

DVD setup menu

You can store the initial disc playback status.

- While playing, no change can be made on the Setup Menus.
- When shipped from the factory, the on-screen language is set to English. To change the language, see page 60.

Basic setting procedure

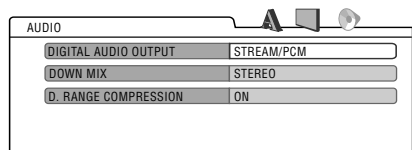
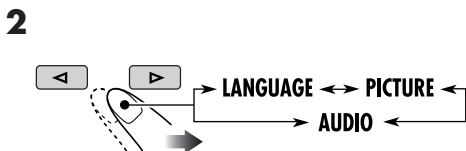
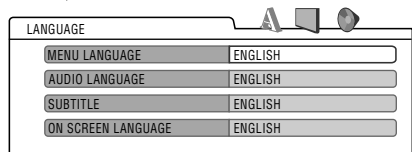
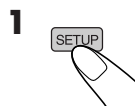

Ex.: When selecting the "AUDIO" screen

3 Select an item you want to set up.

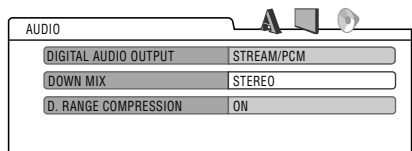
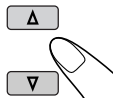

Ex.: When selecting "DOWN MIX"

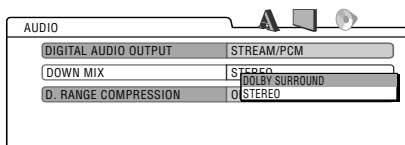

5 select an option.

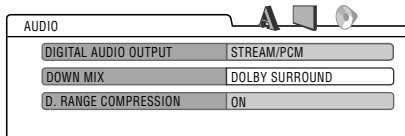
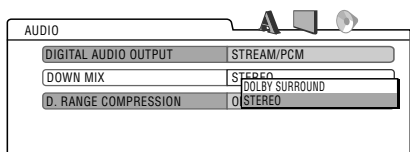
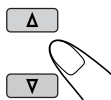

To return to the normal screen





LANGUAGE menu

Item	Contents
MENU LANGUAGE :	Select the initial disc menu language. ENGLISH, SPANISH, FRENCH, GERMAN, ITALIAN, DUTCH, SWEDISH, DANISH, and others.
AUDIO LANGUAGE :	Select the initial audio language. ENGLISH, SPANISH, FRENCH, GERMAN, ITALIAN, DUTCH, SWEDISH, DANISH, and others.
SUBTITLE :	Select the initial subtitle language or erase the subtitle (OFF). OFF (no subtitles), ENGLISH, SPANISH, FRENCH, GERMAN, ITALIAN, DUTCH, SWEDISH, DANISH, and others.
ON SCREEN LANGUAGE :	Select the language for the Setup Menu and some indications shown on the monitor. ENGLISH, SPANISH, FRENCH, GERMAN, ITALIAN, DUTCH, SWEDISH, DANISH.

- For the LANGUAGE settings, see also the language codes list on page 104.



PICTURE menu

Item	Contents
<p>MONITOR :</p>	<p>Select the monitor type to watch a wide screen picture on your monitor.</p> <ul style="list-style-type: none"> • 16:9 : Select this when the aspect ratio of your monitor is 16:9. • 4:3 LETTER BOX : Select this when the aspect ratio of your monitor is 4:3. While viewing a wide screen picture, the black bars appear on the top and the bottom of the screen. • 4:3 PAN SCAN : Select this when the aspect ratio of your monitor is 4:3. While viewing a wide screen picture, the black bars do not appear; however, the left and right edges of the pictures will not be shown on the screen.
<p>OSD POSITION :</p>	<p>Select the on-screen bar position on the monitor.</p> <ul style="list-style-type: none"> • 1 : Higher position • 2 : Lower position (Help screens under the Setup Menu also disappear.)



AUDIO menu

Item	Contents
DIGITAL AUDIO OUTPUT :	<p>Select the signal format to be emitted through the DIGITAL OUT (Optical) terminal on the rear.</p> <ul style="list-style-type: none">• PCM ONLY : Select this when connecting an amplifier or a decoder incompatible with Dolby Digital, DTS, and MPEG Audio, or connecting to a recording device.• DOLBY DIGITAL/PCM : Select this when connecting an amplifier or a decoder compatible with Dolby Digital.• STREAM/PCM : Select this when connecting an amplifier or a decoder compatible with Dolby Digital, DTS, and MPEG Audio.
DOWN MIX :	<p>When playing back a multi-channel DVD disc, this setting affects the signals reproduced through the LINE OUT jacks (and through DIGITAL OUT terminal when “PCM ONLY” is selected for “DIGITAL AUDIO OUTPUT.”)</p> <ul style="list-style-type: none">• DOLBY SURROUND : Select this when you want to enjoy multi-channel surround audio by connecting an amplifier compatible with Dolby Surround to this receiver.• STEREO : Normally select this.
D. RANGE COMPRESSION :	<p>You can enjoy a powerful sound at low or middle volume levels while playing a Dolby Digital software.</p> <ul style="list-style-type: none">• AUTO : Select this to apply the effect to multi-channel encoded software (excluding 1 channel and 2 channel software).• ON : Select this to always use this function.

Other disc operations

In this section, you can learn how to use the buttons on the control panel in order to operate the DVD/CD player.

Basic operations

To stop playback

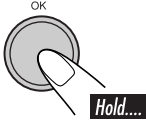

To start playback again

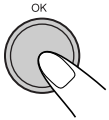

- If you press the button during pause, it is also cancelled.

To replay the previous screens —One Touch Replay



While playing...



To eject a disc



To fast-forward or reverse the chapter/track



The search speed changes to x2 ⇌ x10.

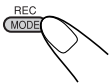

To go to the next or previous chapters/tracks



- For DVD: During play or pause.
- For VCD: While PBC (see page 53) is not in use.

Using the control dial:	Using the number buttons:

To locate a particular title/chapter/folder/track directly



- For DVD: During play or pause—Chapter Before playback—Title
- For VCD: While PBC (see page 53) is not in use.

To select a number from 1 – 6:

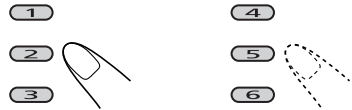

To select a number from 7 – 12:



- To use folder search on MP3/WMA discs, it is required that folders are assigned with a 2-digit number at the beginning of their folder names—01, 02, 03, and so on.
- Number buttons can also be used to select item on the PBC menu.

To skip chapters/tracks quickly



- For DVD: During play or pause.
- For VCD: While PBC (see page 53) is not in use.
- For MP3/WMA: Select a track within the same folder.

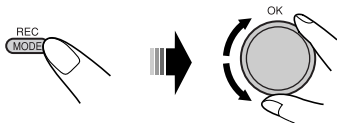

As you rotate the dial, you can skip 10 chapters/tracks at a time.

First time you rotate the dial, the chapter/track skips to the nearest higher or lower chapter/track with a chapter/track number of multiple ten (ex. 10th, 20th, 30th). Then, each time you rotate the dial, you can skip 10 chapters/tracks.

- After the last track, the first chapters/tracks will be selected and vice versa.

To go to the next or previous folders

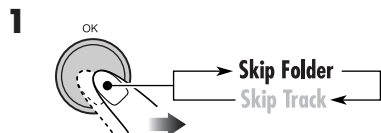

Folder icon is highlighted on the display.

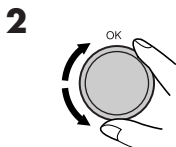
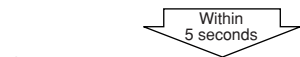

To select a folder/track on the list



You can confirm the title of each item and select the item you want.

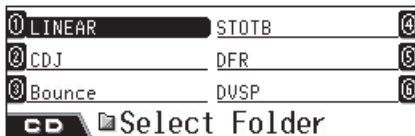

Folder list appears.

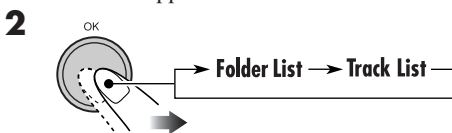

3 Select an item on the list.

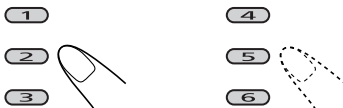

To move to another page of the list, rotate the dial.

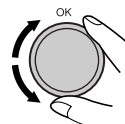

Prohibiting disc ejection

You can lock a disc in the loading slot.



To cancel the prohibition, repeat the same procedure. "Eject OK" flashes.

Selecting the playback modes

You can use only one of the following playback modes at a time.

1

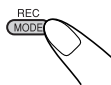

2 Select your desired playback mode.

*1 Only while playing a DVD disc.

*2 Only while playing an MP3 or WMA disc.

Repeat play



- For DVD: During play or pause.
- For VCD: While PBC (see page 53) is not in use.



Mode Plays repeatedly

Chapter *1: One chapter.

- **REP** lights up.

Title *1: One title.

- **T.REP** lights up.

Track: One track.

- **TR.EP** lights up.

Folder *2: All tracks of the folder.

- **F.REP** lights up.

Off: For DVD: Cancels Repeat play.

For other discs: All tracks of the disc.

Random play



Mode Plays at random

Folder *2: All tracks of the folder, then tracks of the next folder and so on.

- **RND** lights up.

Disc: All tracks of the disc.

- **D.RND** lights up.

Off: Cancels.

Intro scan

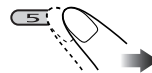

Mode Plays the first 15 seconds of

Track: All tracks of the disc.

- **INT** lights up.

Folder *2: First track of every folder.

- **F.INT** lights up.

Off: Cancels.

To cancel the playback mode



- You can also cancel it by selecting "Off" in step 2.

Changing the display information

• For MP3/WMA discs

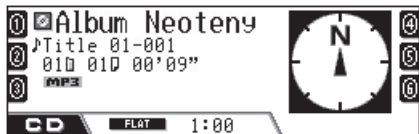
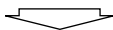

Album title/performer or folder name is enlarged.



Track title or track name is enlarged.

• For CD Text/Audio CD

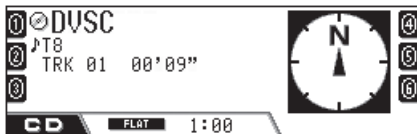
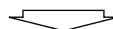
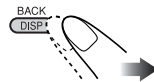

Disc title/performer or your assigned disc name is enlarged.

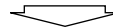

Track title is enlarged.

Icons	Meanings
	Folder name icon
	Track name icon
	Disc title icon
	Album title (Tag) icon
	Track title (Tag) icon
	MP3 format
	WMA format

HDD operations

Playing genre/album/track in the HDD

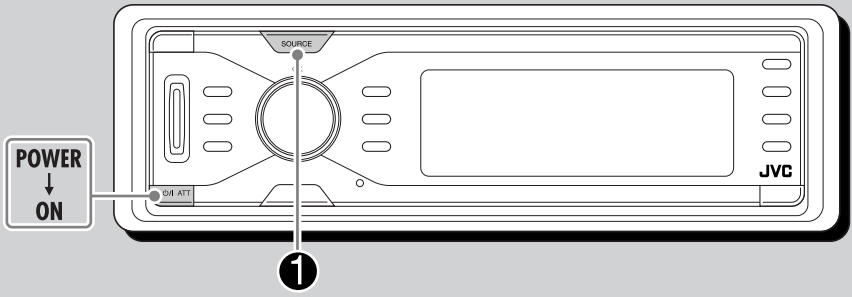

About the HDD

The built-in HDD works not only as storage for navigation data, but as Music Server where you can record 99 albums in each genre folder (total 99 genre folders can be made).

- Each album can include 999 tracks.
- Playlists can also be made and played.

To record CDs, see “Recording audio CDs” on page 70.

To copy MP3/WMA files from an SD card into the HDD, see page 82.

To edit the contents of the HDD, see “Editing the HDD contents” on page 72.

1

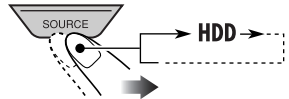

The last selected track starts playing.

- All tracks in the HDD will be played repeatedly until you change the source.
- WMA Tag cannot be displayed during HDD playback.

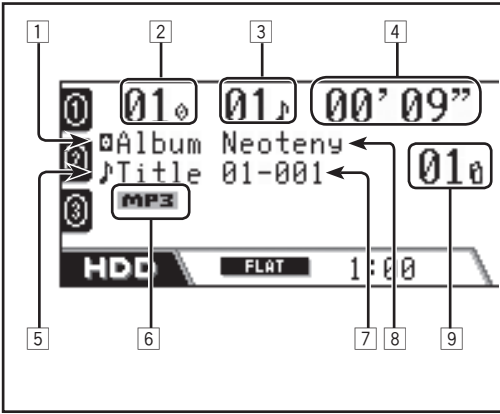

1	Album name icon/Album title (Tag) icon
2	Album number
3	Track number
4	Elapsed playing time
5	Track name icon/Track title (Tag) icon
6	Recording format—MP3/WMA/CDC*
7	Track title or track name
8	Album title/performer or album name
9	Genre number

* CDC:CD compression—format used for storing CD tracks into the HDD. Either <.llc> or <.bsc> is used as an extension code (see page 71).

To go to the next or previous track

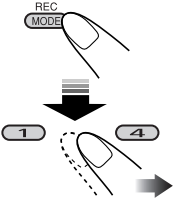
Using the control dial:	Using the number buttons:
	

- By using the number buttons (1 – 6), you can also go directly to tracks 1 – 12.
 - For tracks 1 – 6: Press **1 – 6**.
 - For tracks 7 – 12: Press and hold **1 – 6**.

To skip tracks quickly

You can skip tracks within the same album.

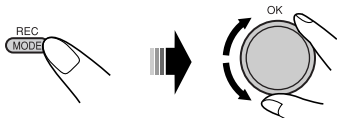

As you rotate the dial, you can skip 10 tracks at a time.

First time you rotate the dial, the track skips to the nearest higher or lower track with a track number of multiple ten (ex. 10th, 20th, 30th). Then, each time you rotate the dial, you can skip 10 tracks.

- After the last track, the first track will be selected and vice versa.

To go to the next or previous albums / genres



- The icon for the selected item is highlighted on the display (except track icon).
- During playlist playback, this does not work. You can skip tracks only.

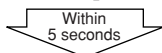

2

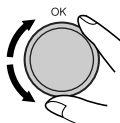

To select a track/album/genre on the list

You can confirm the title of each item and select the item you want.

- To select a playlist, see page 70.

1

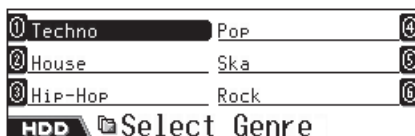
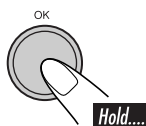

Genre list appears.

2



- * During playlist playback, the track list included in the current playlist is displayed.

3 Select an item on the list.

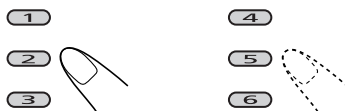

To move to another page of the list, rotate the dial.

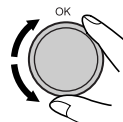

Selecting the playback modes

You can use only one of the following playback modes at a time.

1

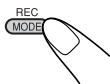

2 Select your desired playback mode.

Repeat play



Mode Plays repeatedly

- Track:** One track.
 • **REPT** lights up.
- Album:** All tracks of the album.
 • **ALB REPT** lights up.
- Genre:** All tracks in the genre.
 • **GENRE REPT** lights up.
- Off:** Cancels.

Random play



Mode Plays at random

- Album:** All tracks of the album.
 • **ALB RND** lights up.
- Genre:** All tracks of the genre.
 • **GENRE RND** lights up.
- All:** All tracks in the HDD.
 • **ALL RND** lights up.
- Off:** Cancels.

Intro scan

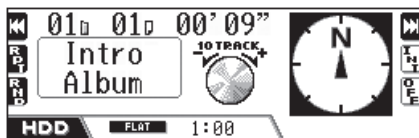

Mode Plays the first 15 seconds of

- Track:** All tracks of the album.
 • **INT** lights up.
- Album:** First track of every album.
 • **ALB INT** lights up.
- Genre:** First track of every genre.
 • **GENRE INT** lights up.
- Off:** Cancels.

To cancel the playback mode



- You can also cancel it by selecting “Off” in step 2.
- HDD playback mode is also cancelled in the following cases:
 - When you record an audio CD into the HDD (see page 70).
 - When you duplicate the data in the SD into the HDD (see page 82).

Changing the display information

• For normal playback

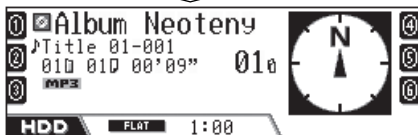
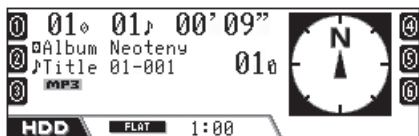
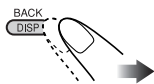

Album title/performer or album name is enlarged.

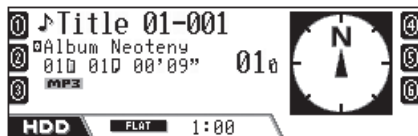

Track title or track name is enlarged.



Genre name is enlarged.

• For playlist playback

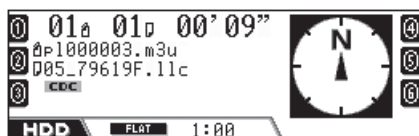
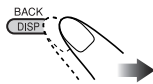

Playlist name is enlarged.

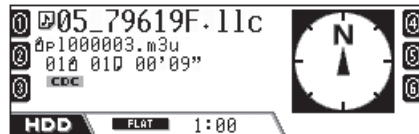

Track title or track name is enlarged.

Icons	Meanings
	Genre name icon
	Album name icon
	Track name icon
	Playlist name icon
	Album title (Tag) icon
	Track title (Tag) icon
MP3	MP3 format
WMA	WMA format
CDC	CDC format

Playing playlists

You can display the lists of the playlists stored, then select the one you want to play.

- To make your own playlists, see page 75.

1

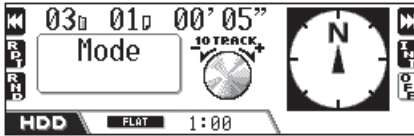
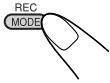

2 Display the list of the playlists.

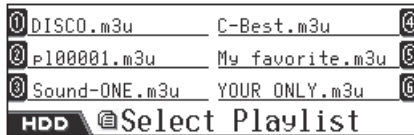
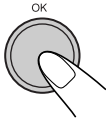

3 Select the playlist, and start playback.

- If more than six playlists exist, rotate the dial to show other playlists, then press...

1

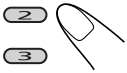

4

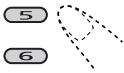

To cancel the playlist playback, select a genre or an album after displaying the list (see page 67).

Recording audio CDs

You can only record audio CD (CD-DA) tracks into the HDD.

- While the following recording/editing process:
 - To return to the previous screens, press **BACK (DISP)** repeatedly.
 - To cancel it, press and hold **BACK (DISP)**.

1 While playing a CD...

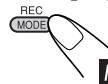

Hold...

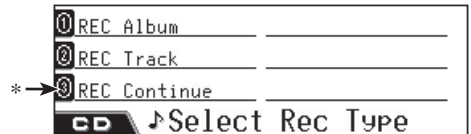

- * This appears only after you have cancelled recording (but have neither ejected the disc nor edited the HDD contents).

2 Select the recording type.

1

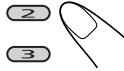

3

- **REC Album:** Records the entire CD from its first track.
- **REC Track:** Records the current track from its beginning.
- **REC Continue:** Continues the previously cancelled recording from the track being recorded when cancelled.

➔ Go to step 6.



3 Select the genre to store the recording into.

- If more than six genres exist, rotate the dial to show other genres, then press...

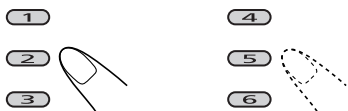

- If you want to create a new genre folder, select “New Genre.”

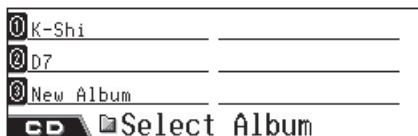

4 Select the album to store the recording into.

- When you have selected “REC Album,” this step is skipped.
- If more than six albums exist, rotate the dial to show other albums, then press...

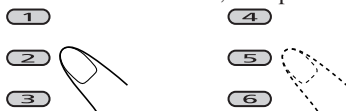

- To store the track into a new album, select “New Album.”

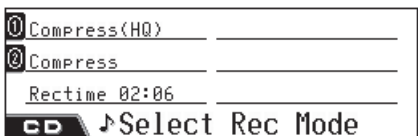

5 Select the recording mode.

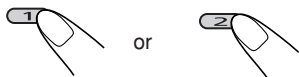

- Compress (HQ):** High quality lossless recording, but data size is bigger—extension code <.llc>.
- Compress:** More compressed recording, so data size becomes smaller—extension code <.bsc>.
- Rectime:** shows the total play time of the recording.

6 Start recording.



7 When the following screen appears, stop recording.



- Recording is finished before playback is over. Once you stop the recording, CD playback resumes.
- Track names are automatically assigned with the extension code <.llc> or <.bsc>.
- Even if you do not stop recording manually, recording is automatically stored.
- When you have selected “New Genre” or “New Album,” its title will be assigned automatically such as <ge000001>, <ge000002>, or <al000001>, <al000002>. You can change the title later manually (see page 72).

To cancel the recording



Recording will be cancelled in the following cases:

- If you turn off the power or switch off the car ignition switch.
- If you detach the control panel.

To continue the recording, press REC (MODE), then select “REC Continue” (see page 70).

Assigning the titles

You can assign (or change) the title to genres, albums, and playlists.

- You cannot assign titles to tracks.

1 While playing an HDD track...

- For assign the title to a playlist, play the playlist you want.

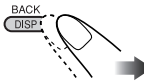
 Enlarge the indication (see also page 69) to which you want to assign a new name (ex. to assign the title to a genre).

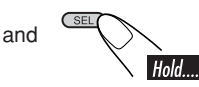

2 Enter the text entry mode.

 and  **Hold...**



3 Assign the title (maximum 32 characters).

- To change the character set...

 →

A - Z / a - z (Upper case/ Lower case)	0 - 9 & symbols (Numbers)
Accented letters (Lower case)	Accented letters (Upper case)

- To enter a character...

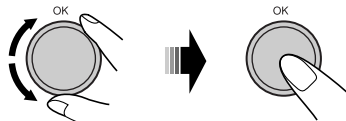

- To move the character entry position...

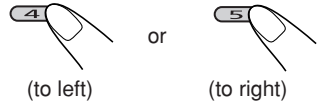

If you press and hold the button, the character entry position moves the first position or the last position.

- To erase a misentry, move the character entry position to the one you want to erase, then...



- To erase the entire entries...

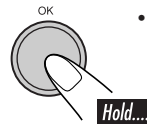

4 After entering the title...

- When you modify the genre or album name, the current track will restart from the beginning.
- 
- Hold...**

Editing the HDD contents

Edit Menus comprises of three main pages (below) and sub-screens.

① Erase Track	Move Track	④
② Erase Album	Move Album	⑤
③ Erase Genre	Sort Album	⑥
⑦ Sort Genre	COPY PL HDD->SD	④
⑧ Entry Tr to PL	COPY PL SD->HDD	⑤
⑨ Erase Playlist	Store Treeinfo	⑥
⑩ Disp HDD Info		

- When one of the Edit Menu is shown, the current track will be played repeatedly.
- While editing the HDD contents, no sounds come out.
- When editing is over, the current playback mode is cancelled, and normal playback will be resumed.

To move between the pages...

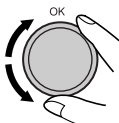

To select the item shown on the display...

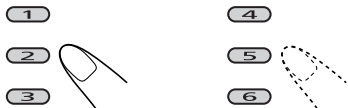

- If more than six items exist on the same level, rotate the dial to display others.

To return to the previous screen...

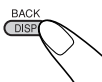

3 Select the one you want to erase.

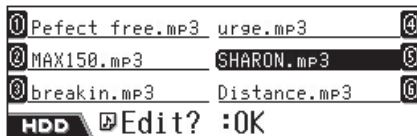
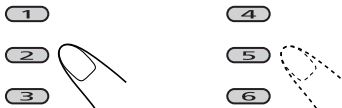

4 Confirm.



- Once editing is finished, playback resumes (from the current track. If the currently playing one is erased, from the track located either before or after the erased one).

Erasing a track/album/genre

Ex. To erase an unwanted track

1 While playing an HDD track...

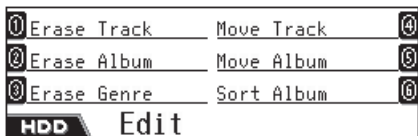

2 Select one of the “Erase” functions.

- 1** : To erase the track within the current album
- 2** : To erase the album within the current genre
- 3** : To erase the genre

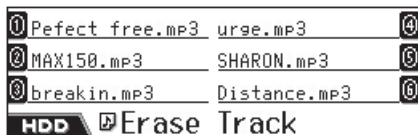

Moving a track/album

You can move the current track into another album or current album into another genre.

Ex. To move the track

1 While playing an HDD track/album you want to move...

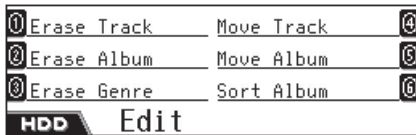

2 Select one of the “Move” functions.

- 4** : To move the track
- 5** : To move the album

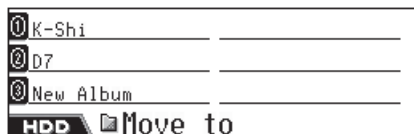

To be continued...

3 Select an album to move the track into.

- For “Move Album”: select the genre to move the album into.

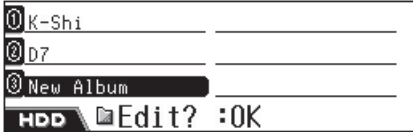

4 Confirm.

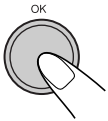

- Once editing is finished, playback resumes (from the tracks in the currently playing album/genre).

Sorting an album/genre

You can change the current album priority in a genre and the current genre priority in the HDD.

This is important since the tracks in the HDD will be played back in the sequence of the listed genre and album.

Ex. To sort the album

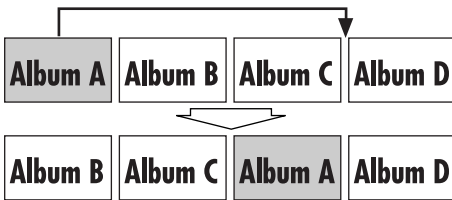

1 While playing an HDD track in an album or genre you want to sort...



2 Select one of the “Sort” functions.

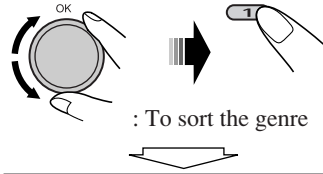
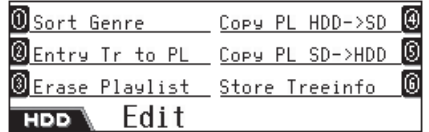
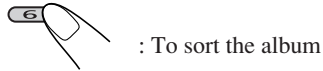
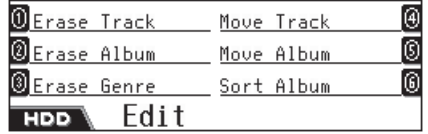

The current album is reversed on the list.

3 Select the album the next to which you move the current album.

- For “Sort Genre”: select the genre the next to which you move the current genre.

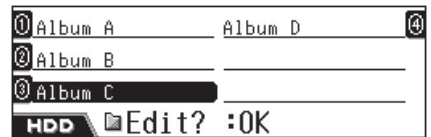

4 Confirm.

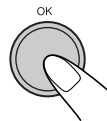

- Once editing is finished, playback resumes (from the tracks in the sorted album/genre).

■ Creating/editing a playlist

You can create a playlist by entering the current track into a new playlist. You can also add tracks into the existing playlist.

- You can create 99 playlists.

1 While playing an HDD track you want to add in a playlist...

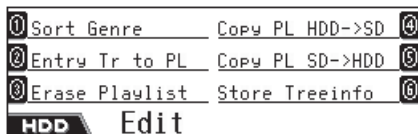
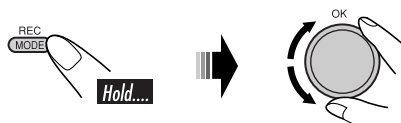

2 Select "Entry Tr to PL."

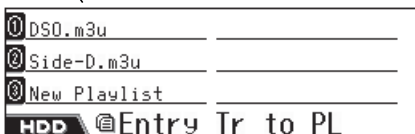

3 Select the playlist you want to add the track into.

- To add the track into a new playlist, select "New Playlist."

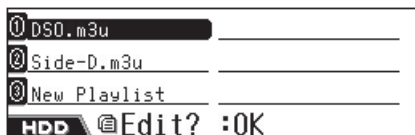
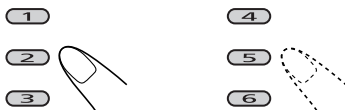

4 Confirm.



- Once editing is finished, playback resumes (from the current track).

- When you have selected "New Playlist," its title will be assigned automatically such as <pl000001.m3u>, <pl000002.m3u>.

You can change the playlist name later manually (see page 72).

5 Repeat the above steps until you enter all tracks you want.

- You can include up to 99 tracks in a playlist.

■ Erasing a playlist

1 While playing an HDD track...

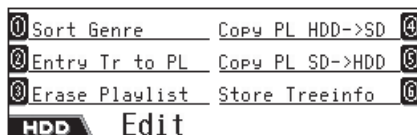
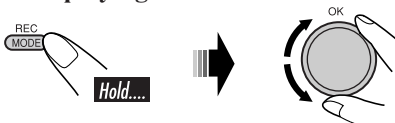

2 Select "Erase Playlist."

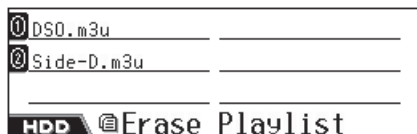
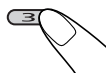

To be continued...

3 Select an unwanted playlist.

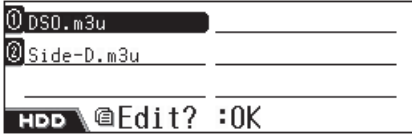
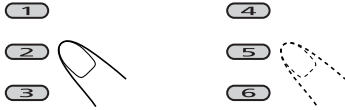

4 Confirm.



- Once editing is finished, playback resumes (from the current track).

Duplicating a playlist

You can copy playlists from the HDD to an SD card or vice versa. By using this function, you can edit the playlists stored in the HDD using your own PC.

Basic procedure:

- 1 Insert an SD (see page 78).
- 2 Copy the playlists in the HDD into the SD—using “Copy PL HDD->SD.”
- 3 Copy the playlists from the SD into your PC, edit them on your PC (see page 77 for editing), then copy the edited playlist into the SD.
- 4 Insert the SD again, then copy the edited playlists into the HDD—using “Copy PL SD->HDD.”

1 While playing an HDD track...

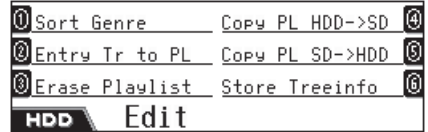
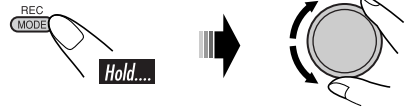

2 Select one of the “Copy” functions.

- 4 : From HDD to SD
- 5 : From SD to HDD

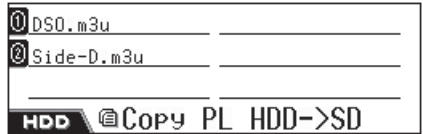

3 Select a playlist you want copy.

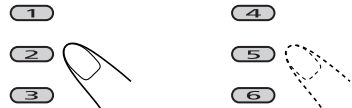

4 Confirm.



- Once editing is finished, playback resumes (from the current track).

- If the same named playlist exists, it is overwritten.

Storing tree information into SD

You can export the tree information (folder structure) of the HDD into an SD card. This makes it easy for you to make a new playlist when many genres/albums/tracks are recorded in the HDD.

- Before starting, insert an SD card.

1 While playing an HDD track...

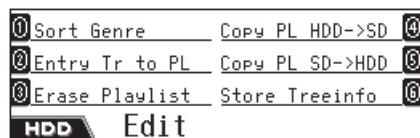
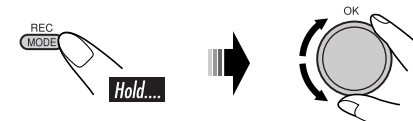

2 Select “Store Treeinfo.”

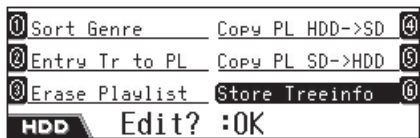

3 Confirm.

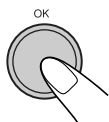

- Once editing is finished, playback resumes (from the current track).
- Tree information is stored in the loaded SD as <contents.txt>.

The <contents.txt> file will be displayed on your PC as follows.

```

/m_data/music/genre1/album1/track1.mp3
/m_data/music/genre1/album1/track2.mp3
/m_data/music/genre1/album1/track3.wma
/m_data/music/genre1/album1/track4.wma
.....
    
```

To make a playlist from this file, use a text editor on your PC.

Start the first line with <#EXTM3U>, then list the tracks in the playback sequence as the example below.

```

#EXTM3U
/m_data/music/genre1/album1/track2.mp3
/m_data/music/genre2/album4/track11.mp3
/m_data/music/genre4/album5/track4.wma
.....
    
```

- Save a file with the extension code <.txt>, then manually change the extension code to <.m3u>.

To copy the file into the HDD, save it in <list> folder under <JVCMS> folder as described on page 78.

Confirming the HDD contents

You can confirm the contents of the HDD.

1 While playing an HDD track...

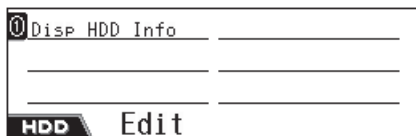
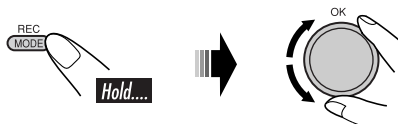

2 Select “Disp HDD Info.”

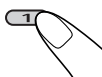

To erase the HDD Info screen...



SD operations

Inserting the SD card

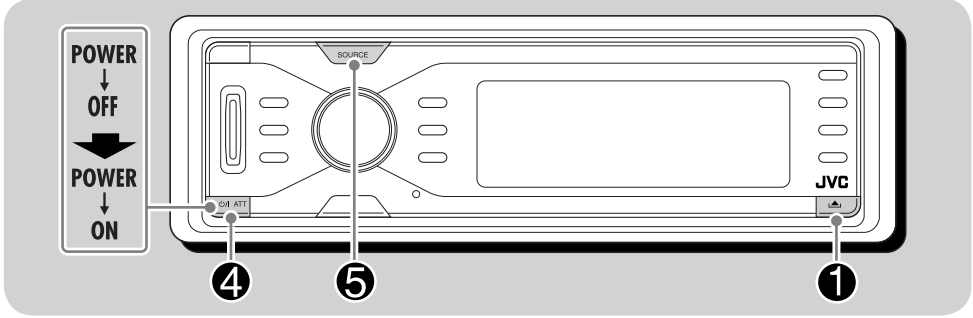

To play the tracks in an SD card, it must be configured strictly as follows:

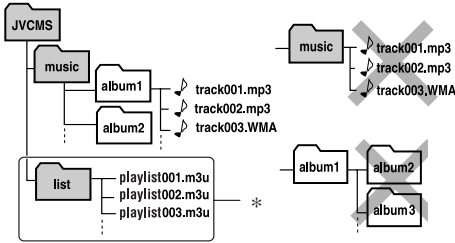

- Top folder must be titled <JVCMS> (JVC Music Server), the folder including album folder must be <music>.
 - DO NOT store the files directly in <music>.
 - DO NOT make any folders in album folders.
- Album titles and track titles can be assigned as you like; however, track must have their extension code such as <.mp3> <.wma>.
- <music> folder can include up to 99 album, and each album can include up to 999 tracks.
- SD cards are precision products. DO NOT impact, bend, drop, or wet them.

* *Playlists in the <list> folder cannot be played, but can be copied into the HDD (see page 77).*

You can play back MP3/WMA tracks recorded in an SD card, and also copy the MP3/WMA tracks in the SD into the HDD.

- WMA Tag cannot be displayed during SD playback.
- Turn off the power before detaching the control panel.

1 Detach the control panel.

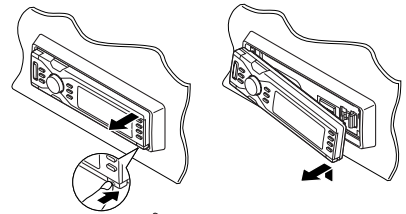

2

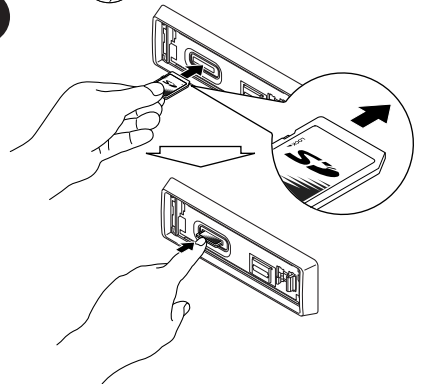

Press in SD until you hear a clicking sound.

To eject SD, press the SD as illustrated.

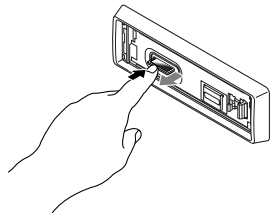

- Press the SD softly (do not release your finger quickly); otherwise, the SD may pop out from the unit.
- When you pull out the SD, pull it out straightly from the loading slot.

5

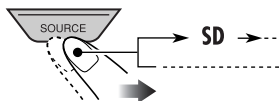

Playback starts automatically in the alphabetical order of the album name/track name.

3

Attach the control panel.

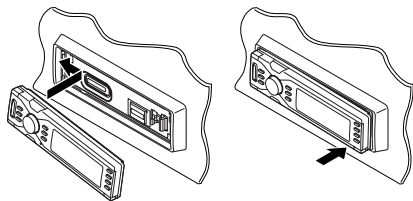

4

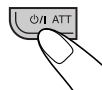

- The control panel goes back to the previous position (see page 92).

1	Album name icon/Album title (Tag) icon
2	Album number
3	Track number
4	Elapsed playing time
5	Track name icon/Track title (Tag) icon
6	Recording format
7	Track title or track name
8	Album title/performer or album name

To go to the next or previous track

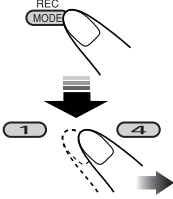
Using the control dial:	Using the number buttons:
	

- By using the number buttons (1 – 6), you can also go directly to tracks 1 – 12.
 - For tracks 1 – 6: Press **1 – 6**.
 - For tracks 7 – 12: Press and hold **1 – 6**.

To skip tracks quickly

You can skip tracks within the same album.

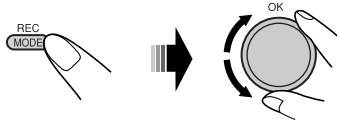

As you rotate the dial, you can skip 10 tracks at a time.

First time you rotate the dial, the track skips to the nearest higher or lower track with a track number of multiple ten (ex. 10th, 20th, 30th). Then, each time you rotate the dial, you can skip 10 tracks

- After the last track, the first track will be selected and vice versa.

To go to the next or previous albums

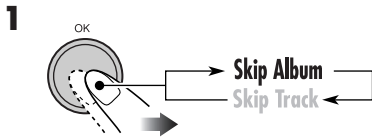

The album icon is highlighted.

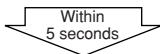

2



To select a track/album on the list

You can confirm the title of each item and select the item you want.

1

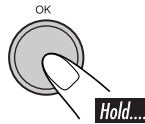

Album list appears.

2

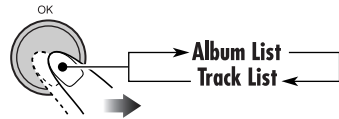

3 Select an item on the list.

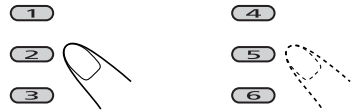

To move to another page of the list, rotate the dial.



Selecting the playback modes

You can use only one of the following playback modes at a time.

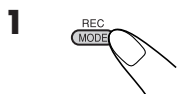

2 Select your desired playback mode.

Repeat play



Mode Plays repeatedly

- Track:** One track.
 • **REPT** lights up.
- Album:** All tracks of the album.
 • **REPT** lights up.
- Off:** Cancels.

Random play

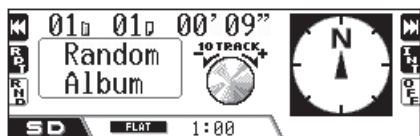

Mode Plays at random

- Album:** All tracks of the album.
 • **RND** lights up.
- All:** All tracks in the SD.
 • **ALLRND** lights up.
- Off:** Cancels.

Intro scan

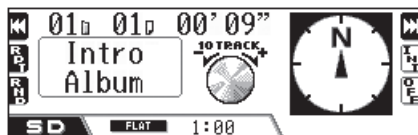

Mode Plays the first 15 seconds of

- Track:** All tracks of the album.
 • **INT** lights up.
- Album:** First track of every album.
 • **INT** lights up.
- Off:** Cancels.

To cancel the playback mode



- You can also cancel it by selecting "Off" in step **2**.

Changing display information

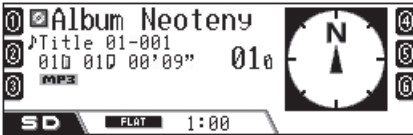
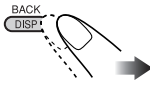

Album title/performer or album name is enlarged.



Track title or track name is enlarged.

Icons	Meanings
	Album name icon
	Track name icon
	Playlist name icon
	Album title (Tag) icon
	Track title (Tag) icon
	MP3 format
	WMA format

Duplicating data into HDD

You can copy the data in the SD card into the HDD.

- While copying the data into the HDD, no sounds come out.
- It takes time to copy a data of much volume (about 5 minutes for 100 MB data—this is just an estimation). Actual time varies depending on the album configuration and the system condition.
- When you duplicate the data in the SD into the HDD, the HDD playback mode is cancelled (see page 68).
- While the following duplicating process:
 - To return to the previous screens, press **BACK (DISP)** repeatedly.
 - To cancel it, press and hold **BACK (DISP)**.

Copying the current track

1

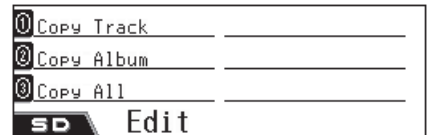

2

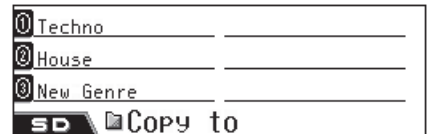
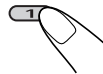

3 Select the target genre you want to copy the track into.

- If more than six genres exist, rotate the dial to show other genres, then press...

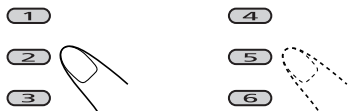

- If you want to create a new genre folder, select “New Genre.”

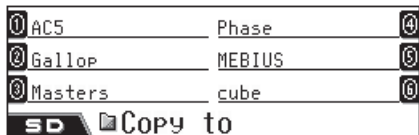

Album list of the selected genre appears.

4 Select the target album you want to move the track into.

- If more than six albums exist, rotate the dial to show other albums, then press...

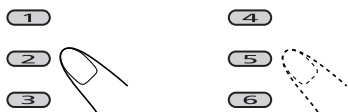

- If you want to create a new album, select “New Album.”

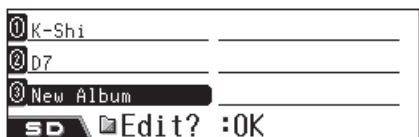

5 Confirm.



- Once editing is finished, playback resumes (from the current track).

Copying the current album/all albums

1

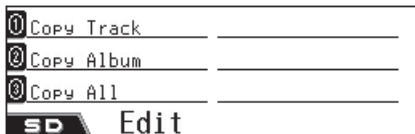

2

- 2 : To copy the current album
- 3 : To copy all albums at a time

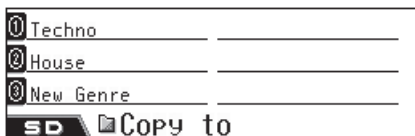

3 Select the target genre.

- If more than six genres exist, rotate the dial to show other genres, then press...

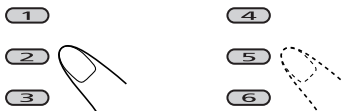

- If you want to create a new genre folder, select “New Genre.”

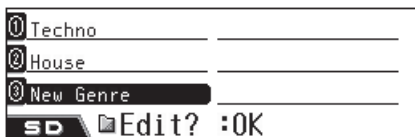

4 Confirm.

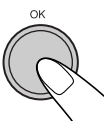

- Once editing is finished, playback resumes (from the current track).

Sound adjustments

Selecting preset sound modes (EQ: equalizer)

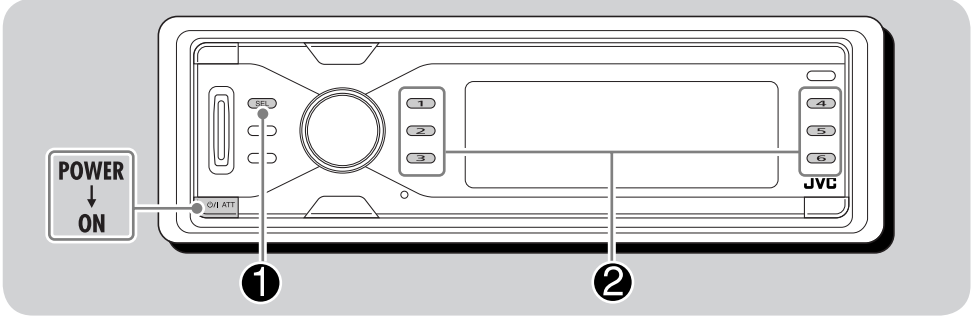

You can select a preset sound mode suitable to the music.

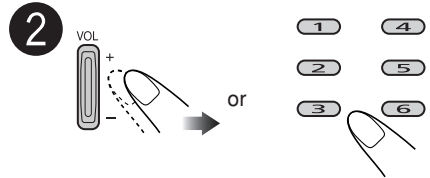
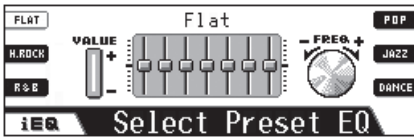
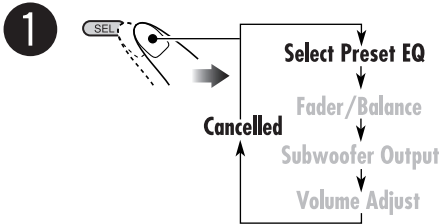

Ex.: When "Hard Rock (H.ROCK)" is selected

- By using the number buttons, you can only select the sound modes shown on the display.

Sound modes (preset frequency level settings)

The list below shows the preset frequency level settings for 12 sound modes.

Sound mode	Preset equalizing values						
	60 Hz	150 Hz	400 Hz	1 kHz	2.4 kHz	6 kHz	12 kHz
Flat	00	00	00	00	00	00	00
Hard Rock	+03	+03	+01	00	00	+02	+01
R&B	+03	+02	+02	00	+01	+01	+03
Pop	00	+02	00	00	+01	+01	+02
Jazz	+03	+02	+01	+01	+01	+03	+02
DanceMusic	+04	+02	00	-02	-01	+01	+01

Storing your own sound adjustments

You can adjust the sound modes and store your own adjustments in memory.

- 1 Select one of the preset sound modes.
 - Repeat steps 1 and 2 on page 84.

- 2 Enter the sound adjustment mode, then select a frequency to adjust.

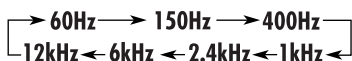
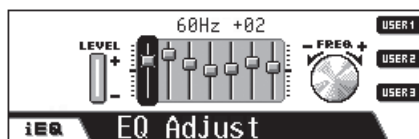
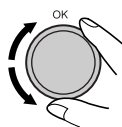

- 3 Adjust the level (-05 to +05).

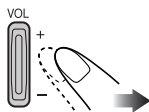

- 4 Repeat steps 2 and 3 to adjust the other frequency bands.

- 5 Select one of the user modes—USER1/2/3.

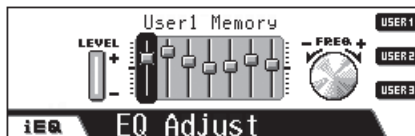
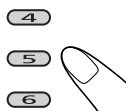

Ex. when "USER1" is selected

Sound mode	Preset equalizing values						
	60 Hz	150 Hz	400 Hz	1 kHz	2.4 kHz	6 kHz	12 kHz
Country	+02	+01	00	00	00	+01	+02
Reggae	+03	00	00	+01	+02	+02	+03
Classics	+02	+03	+01	00	00	+02	00
User1	00	00	00	00	00	00	00
User2	00	00	00	00	00	00	00
User3	00	00	00	00	00	00	00

Adjusting the sound basic settings

You can adjust the sound characteristics to your preference.

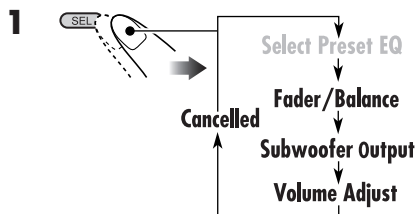

2 Adjust the selected item.

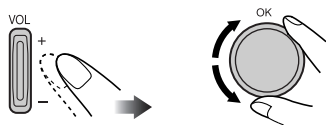

Adjusting fader and balance



Adjust fader—speaker output balance between the front and rear speakers.

- **F06**: Upmost—front only
- **R06**: Downmost—rear only

Adjust the balance—speaker output balance between the left and right speakers.

- **L06**: Leftmost—left only
- **R06**: Rightmost—right only

Adjusting subwoofer output



Select an appropriate cutoff frequency level according to the subwoofer connected.

- **115 Hz/85 Hz/55 Hz**

The frequencies higher than the selected level are cut off to the subwoofer.

Adjust the subwoofer output level.

- **00** (min.) to **08** (max.)

You can also activate or deactivate the High Pass Filter (HPF) by pressing **3**.

When it is activated, “**H**” is displayed in between the output level and the cutoff frequency. Lower frequency signals will be sent only to the subwoofer so that you can enjoy the low frequency effect (LFE) of the DVD software purely from the subwoofer.

Adjusting the input level of each source



This setting is required for each source except FM. Before making an adjustment, select an appropriate source for which you want to make an adjustment.

Once you have made an adjustment, it is memorized, and the volume level will automatically increase or decrease by adjusted level when you change the source.

Adjust to match the input level to the FM sound level.

- **-05** (min.) to **+05** (max.)

- If you adjust it while recording a CD, the input level of the HDD will be adjusted.

General settings — PSM

Basic procedure

You can change PSM (Preferred Setting Mode) items listed in the table that follows.

- 1 
- 2 Select a PSM item.



Ex.: When you select "Scroll"

- 3 Adjust the PSM item selected.

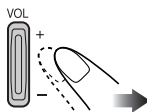

- 4 Repeat steps 2 and 3 to adjust the other PSM items if necessary.

- 5 Finish the procedure.



Indications

Selectable settings, [reference page]

Movie	Demo Display demonstration	Interval: [Initial]; Display demonstration is activated and shown in one-minute intervals. All Time: Display demonstration is activated. Off: Cancels, [14]. • Display demonstration starts if no operation is done for about one minute.
	KeyIn CFM Key-in confirmation	On: [Initial]; Power-on, power-off, source (or compass) animations are activated. Off: Cancels.
Clock	24H/12H Clock system	12Hours ⇄ 24Hours, [14] [Initial: 24Hours]
	Time Time	Set the local time (in one-hour intervals). It is not required to set the minute since it is automatically adjusted by referring to the received GPS signals. [Initial: 00:00]

To be continued...

Indications

Selectable settings, [reference page]

Display	Scroll Scroll	The entire text information can be shown by scrolling if it cannot be shown at a time. Once: [Initial]; Scrolls only once. Auto: Repeats scrolling (in 5-second intervals). Off: Cancels. (For DAB: only shows the headline) • Holding DISP (BACK) can scroll the display regardless of the setting.
	Dimmer Dimmer	Auto: [Initial]; Dims the display when you turn on the headlights. Off: Cancels. On: Activates dimmer. Time Set: Sets the timer for dimmer, [90].
	From– To *1 Dimmer time	Any hour – Any hour, [90] [Initial: 18– 07]
	Contrast Contrast	1 – 10 [Initial: 5]
	LCD Type Display type	Auto: [Initial]; Positive pattern will be selected during the day time*2; while negative pattern will be used during the night time*2. Positive: Positive pattern of the display. Negative: Negative pattern of the display.
	Tag Tag display	On: [Initial]; To show the Tag while playing MP3/WMA tracks. • WMA Tag cannot be shown during HDD/SD playback. Off: Cancels.
	Compass Compass	On: [Initial]; Display the compass (indicating the direction of the north). Off: Display the source animation when “KeyIn CFM” is set to “On.”

Tuner	PTY Stnby PTY Standby	You can select one of the PTY codes for the PTY Standby Reception, [47]. [Initial: News]
	AF-Regn'l Alternate frequency/ regionalization reception	When the received signals from the current station become weak... AF: [Initial]; Switches to another station (the programme may differ from the one currently received), [47]. • AF indicator lights up. AF Reg: Switches to another station broadcasting the same programme. • REG indicator lights up. Off: Cancels (not selectable when “DAB AF” is set to “On”).

*1 Displayed only when “Dimmer” is set to “Time Set.”

*2 Determined by the “Dimmer” setting.

Indications		Selectable settings, [reference page]
Tuner	TA Volume Traffic announcement volume	When a Traffic Announcement is tuned in by TA Standby Reception, the volume level automatically changes to the preset level. [Initial: 15]; Volume 0 – Volume 30 or Volume 50* ³
	P-Search Programme search	On: The receiver tunes in to another frequency broadcasting the same programme as the original preset RDS station is if the preset station signals are not sufficient. Off: [Initial]; Cancels.
	IF Filter Intermediate frequency filter	Auto: [Initial]; Increases the tuner selectivity to reduce interference noises between the stations. (Stereo effect will be degraded.) Wide: Subject to the interference noises from adjacent stations, but sound quality will not be degraded. (Stereo effect will not be degraded.)
	DAB AF * ⁴ Alternative frequency reception	On: [Initial]; Tracks the programme among DAB services and FM RDS stations, [102]. • AF indicator lights up. Off: Cancels.
	Announce * ⁴ Announcement standby reception	Select one of the 9 announcement types for Announcement Standby Reception, [102]. Travel [Initial]/ Warning/News/Weather/Event/Special/Rad Inf/Sports/Finance
Audio	Beep Beep	On: [Initial]; Beep sounds when you operate the unit. Off: Cancels.
	ExtInput * ⁵ External Input	Changer: [Initial]; To use a JVC CD changer. Ext In: To use any external component.
	Telephone Telephone muting	Muting1/Muting2: Select either one which mutes the sounds while using the cellular phone. (This does not affect the route guidance.) Off: [Initial]; Cancels.
	Amp Gain Amplifier gain control	You can change the maximum volume level of the unit. High Pwr: [Initial]; Volume 0 – Volume 50 Low Pwr: Volume 0 – Volume 30 (Select this if the maximum power of the speaker is less than 50 W to avoid damaging the speaker.) Off: Deactivates the built-in amplifier.

*³ Depends on the amplifier gain control.*⁴ Displayed only when the DAB tuner is connected.*⁵ Not display when CD changer or external component is selected for the source.

Selecting the dimmer mode

You can dim the display at night or as you set the timer.

1



2 Select "Dimmer."



3 Select one of the following options.

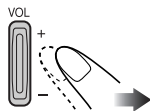

Auto: Dims the display when you turn on the headlights.

➔ Go to step **8**.

Off: Cancels.

➔ Go to step **8**.

On: Always dims the display.

➔ Go to step **8**.

Time Set: Set the timer for dimmer.

➔ Go to step **4**.

4 Select "From- To."



5 Set the dimmer start time.

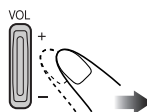

6 Move the flashing point to the end time.



7 Set the dimmer end time.

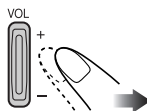

8 Exit from the setting.



Assigning titles to the sources

You can assign titles to CDs (both in this receiver and in the CD changer), and external component.

- To assign the titles to the HDD contents, see page 72.

Sources	Maximum number of characters
CDs/CD-CH	Up to 32 characters (up to 30 discs)
External component	Up to 16 characters

- You cannot assign a title to DVD, VCD, CD Text or an MP3/WMA disc.

1 Select the source.

- For a CD in this receiver: Insert a CD.
- For CDs in the CD changer: Select “CD-CH,” then select a disc number.
- For external component: Select “LINE IN.”

2 Enter the title assignment screen.

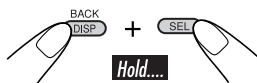

Ex. when you select CD as the source

3 Assign a title.

1 Select a character set.

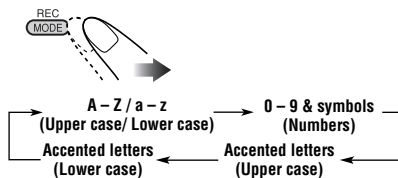

2 Select a character.

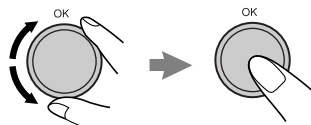

3 Move to the next (or previous) character position.

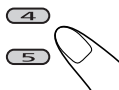

- If you press and hold the button, the character position moves to the beginning (or the last).
- To erase a misentry, move the character entry position to the one you want to erase, then...



4 Repeat steps 1 to 3 until you finish entering the title.

4 Finish the procedure.



To erase the entire title

In step 2...

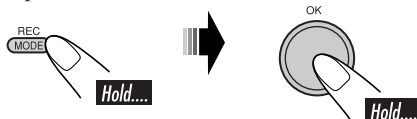

Changing the control panel angle

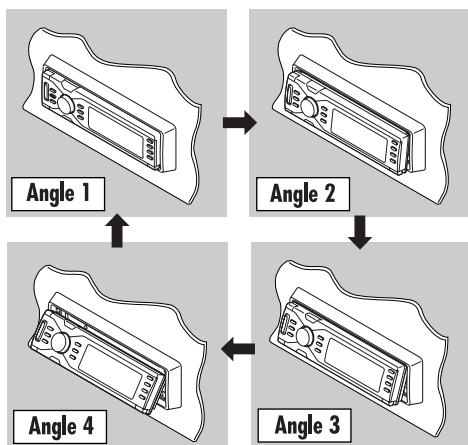
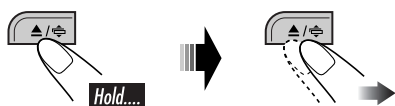

Warning:

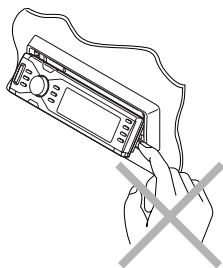

Detaching the control panel

When detaching or attaching the control panel, be careful not to damage the connectors on the back of the control panel and on the panel holder.

■ Detaching the control panel

Before detaching the control panel, be sure to turn off the power.

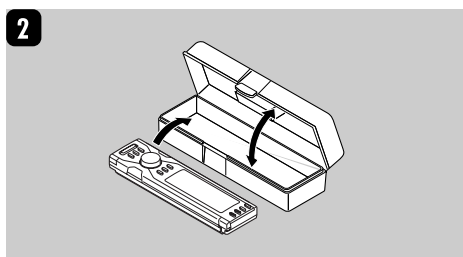
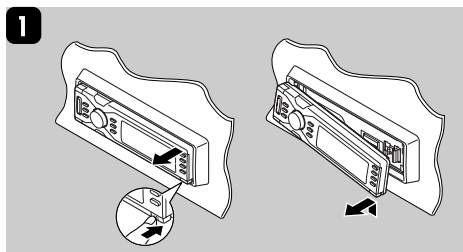

■ Attaching the control panel

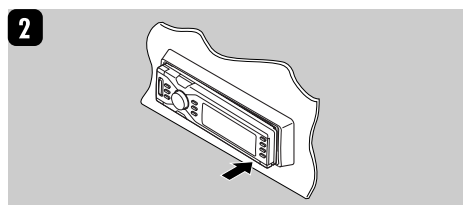
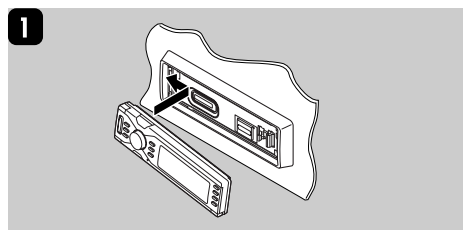

CD changer operations

Playing discs in the CD changer

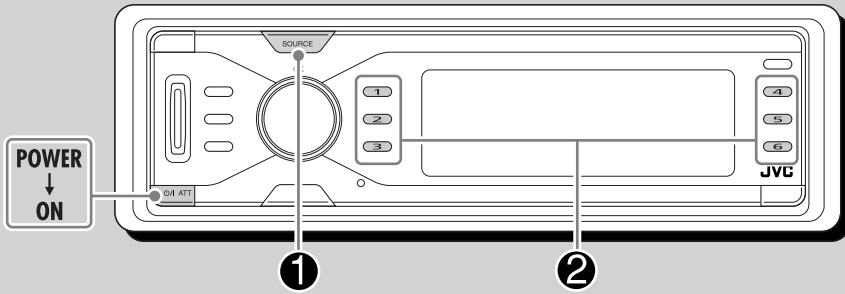

About the CD changer

It is recommended to use the JVC MP3-compatible CD changer with your receiver.

- You can also connect other CH-X series CD changers (except CH-X99 and CH-X100). However, they are not compatible with MP3 discs, so you cannot play back MP3 discs.
- You cannot use the KD-MK series CD changers with this receiver.
- Disc text information recorded in the CD Text can be displayed when a JVC CD Text compatible CD changer is connected.

Before operating your CD changer:

- Refer also to the Instructions supplied with your CD changer.
- You cannot control and play any DVD, VCD, and WMA disc in the CD changer.

1

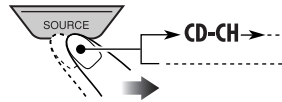

All tracks of the inserted discs will be played repeatedly.

2

Select a disc.

For disc number from 1 – 6:

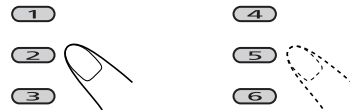

For disc number from 7 – 12:



While playing MP3 discs:

The diagram shows an MP3 player display with the following elements and callouts:

- 1: Folder name icon/Album title (Tag) icon
- 2: Folder number (01)
- 3: Track number (01)
- 4: Elapsed playing time (00' 09'')
- 5: Track name icon/Track title (Tag) icon
- 6: MP3 icon
- 7: Track title or track name (Title 01-001)
- 8: Album name/performer or folder name (Album Neoteny)
- 9: Disc number (01)

1	Folder name icon/Album title (Tag) icon
2	Folder number
3	Track number
4	Elapsed playing time
5	Track name icon/Track title (Tag) icon
6	MP3 icon
7	Track title or track name
8	Album name/performer or folder name
9	Disc number

While playing CD Text/Audio CD:

The diagram shows a CD player display with the following elements and callouts:

- 1: Disc title icon
- 2: Track number (TRK 01)
- 3: Elapsed playing time (00' 09'')
- 4: Track title icon
- 5: Track title (Jet Mountain)
- 6: Disc title/performer or your assigned disc name (DS04)
- 7: Disc number (01)

1	Disc title icon
2	Track number
3	Elapsed playing time
4	Track title icon
5	Track title
6	Disc title/performer or your assigned disc name
7	Disc number

To go to the next or previous tracks

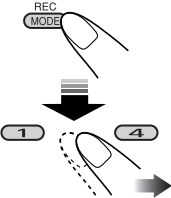
Using the control dial:	Using the number buttons:
	

To skip tracks quickly

This operation is only possible when using JVC MP3-compatible CD changer.



As you rotate the dial, you can skip 10 tracks at a time.

First time you rotate the dial, the track skips to the nearest higher or lower track with a track number of multiple ten (ex. 10th, 20th, 30th).

Then, each time you rotate the dial, you can skip 10 tracks.

- After the last track, the first track will be selected and vice versa.
- For MP3: You can skip tracks only within the same folder.

To go to the next or previous folders (only for MP3)

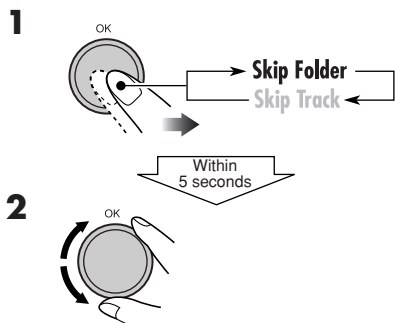

To fast-forward or reverse the track



To select a track/folder/disc on the list

You can confirm the title of each item and select the item you want.

- For CD Text/Audio CD: You can only display the disc list.

1



Disc list appears.

2 For MP3 discs only: Change to the list you want to use.



3 Select an item on the list.

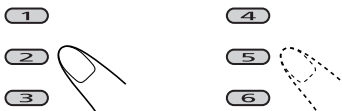

To move to another page of the list, rotate the dial.



Selecting the playback modes

You can use only one of the following playback modes at a time.

1

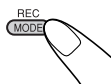

2 Select your desired playback mode.

Repeat play

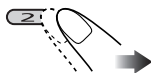

Mode Plays repeatedly

- Track:** One track.
- **RPT** lights up.
- Folder** *1: All tracks of the folder.
- **RPT** lights up.
- Disc:** All tracks of the disc.
- **RPT** lights up.
- Off:** Cancels.

Random play



Mode Plays at random

- Folder** *1: All tracks of the folder, then tracks of the next folder and so on.
- **RND** lights up.
- Disc:** All tracks of the disc.
- **RND** lights up.
- All:** All tracks of the inserted discs.
- **ALL RND** lights up.
- Off:** Cancels.

Intro scan



Mode Plays the first 15 seconds of

- Track:** All tracks of the current disc.
- **INT** lights up.
- Folder** *1: First track of every folder.
- **INT** lights up.
- Disc:** First track of every inserted disc.
- **INT** lights up.
- Off:** Cancels.

*1 Only while playing an MP3 disc.

To cancel the playback mode

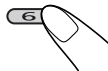

- You can also cancel it by selecting “Off” in step 2.

Changing the display information

• For MP3 discs

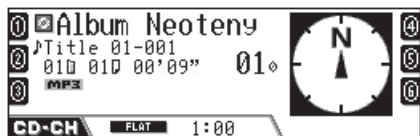
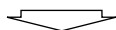
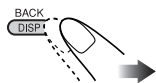

Album name/performer or folder name is enlarged.



Track title or track name is enlarged.

• For CD Text/Audio CD

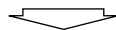
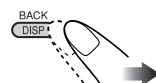

Disc title/performer or your assigned disc name is enlarged.

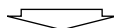

Track title is enlarged.

Icons	Meanings
	Folder name icon
	Track name icon
	Disc title icon
	Album title (Tag) icon
	Track title (Tag) icon
	MP3 format

External component operations

Playing an external component

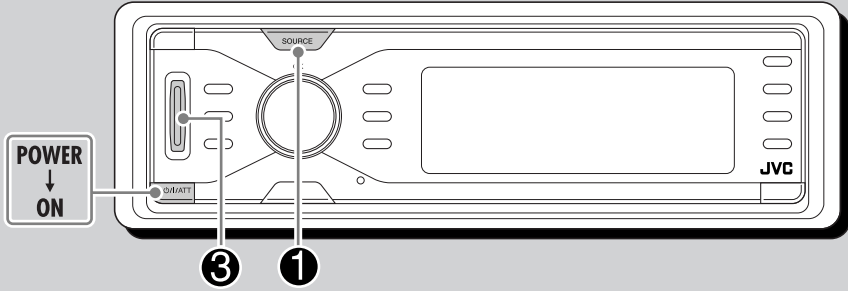

You can connect an external component to the CD changer jack on the rear using the Line Input Adapter KS-U57 (not supplied) or Aux Input Adapter KS-U58 (not supplied).

- For connection, see Installation/Connection Manual (separate volume).

1

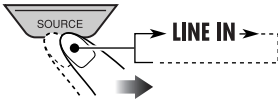

- If you cannot select “LINE IN,” select “Ext In” for “ExtInput” in the PSM setting (see page 89).

2

Turn on the connected component and start playing the source.

3

Adjust the volume.



4

Adjust the sound as you want.
(See page 84.)

DAB tuner operations

Listening to the DAB service

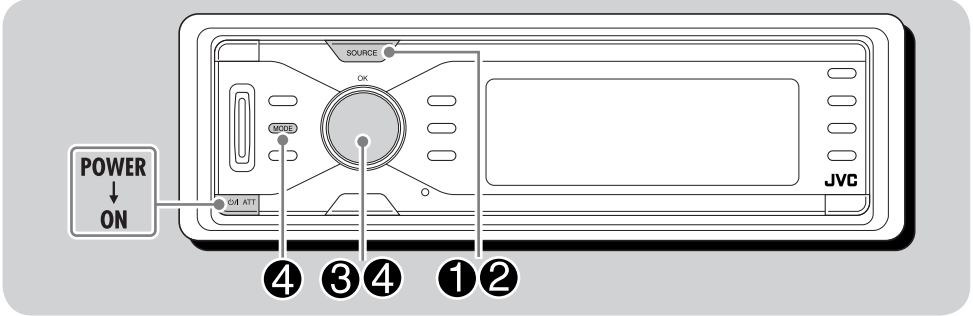

It is recommended to use DAB (Digital Audio Broadcasting) tuner KT-DB1000 with your receiver. If you have another DAB tuner, consult your JVC IN-CAR ENTERTAINMENT dealer.

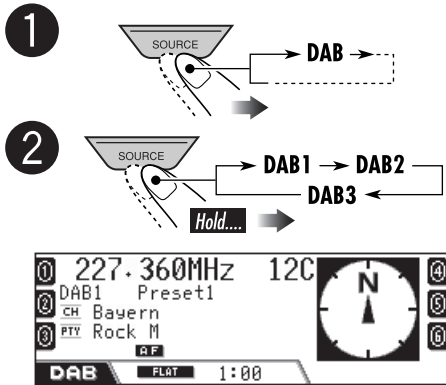

3 Start searching for an ensemble.



When an ensemble is received, searching stops.

To stop searching, press **OK**.

4 Select a service (either primary or secondary) to listen to.

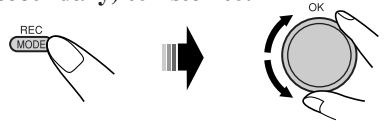

1	DAB band
2	Ensemble frequency
3	Channel (ensemble) number
4	Channel (ensemble) icon
5	PTY icon
6	TP indicator
7	PTY indicator
8	AF indicator (see page 89)
9	ANN indicator
10	DRC indicator
11	Programme type (PTY: see page 45)
12	Channel (ensemble) name

To tune in to an ensemble manually

In step ③...

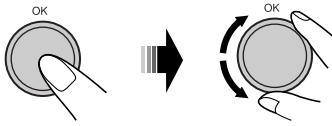

Storing DAB services in memory

You can preset six DAB services (primary) for each band.

- 1 Perform steps ① to ④ on page 99, to select a service you want.
- 2 Select the preset number (1 – 6) you want to store into.



Preset number flashes for a while.

Tuning in to a preset DAB service

1

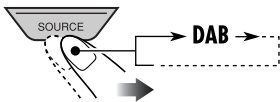

2

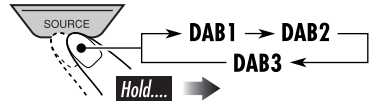

- 3 Select the preset DAB service (primary) number (1 – 6) you want.

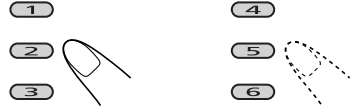

If the selected primary service has some secondary services, press the same button repeatedly will tune in to the secondary services.

To select a preset service on the list

- 1 Select “DAB,” then the band.

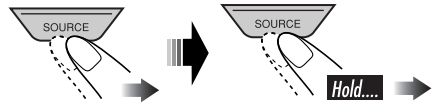

- 2 Display the preset station list.

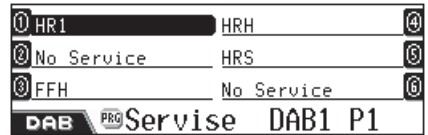

- Rotate the dial to display the lists for the other bands.

- 3 Select the preset service.

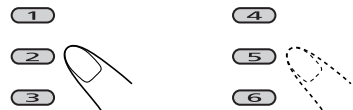

When a service is hard to listen to

You can reinforce the low level sounds, which is hard to listen to while driving, to improve your listening if the currently received service provides Dynamic Range Control (DRC) signals.

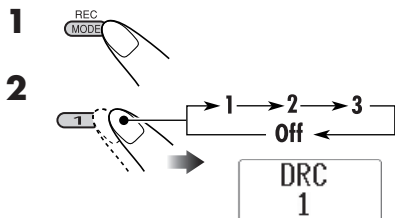

- The higher the number is, the stronger the reinforcement becomes.
- When this function is activated, DRC indicator lights up on the display.



Then when the DRC signals are detected, **DRC** turns to be **DRC**.

What you can do with DAB

DAB can deliver CD quality sound without any annoying interference and signal distortion. Furthermore, it can carry text, pictures, and data.

By connecting the DAB tuner, this receiver can do the following:

- Programme Type (PTY) Search
- Standby Reception of Traffic Announcement (TA) or your favorite programme (PTY)
- Tracking the same programme automatically —Alternative Frequency Reception (see “DAB AF” on page 89)

Searching for your favorite programme

You can tune in to a service broadcasting your favorite programme by searching for a PTY code.

- Operations are exactly the same as explained on page 45 for FM RDS stations.
- You cannot preset the PTY codes separately for DAB tuner and for FM tuner.

Using the Standby Reception

TA (Road Traffic News) Standby Reception

- Operations are exactly the same as explained on page 46 for FM RDS stations.
- You cannot activate TA Standby Reception separately for the DAB tuner and for FM tuner.

PTY Standby Reception

- Operations are exactly the same as explained on page 47 for FM RDS stations.
- PTY Standby Reception for DAB tuner works only using a dynamic PTY code.
- You can neither store your favorite PTY nor activate PTY Standby Reception separately for the DAB tuner and for the FM tuner.
- You can activate and deactivate PTY Standby Reception when the source is either “FM” or “DAB.”

To be continued...

Announcement Standby Reception

Announcement Standby Reception allows the receiver to switch temporarily to your favorite service (announcement type).

To select your favorite announcement type, see page 89.

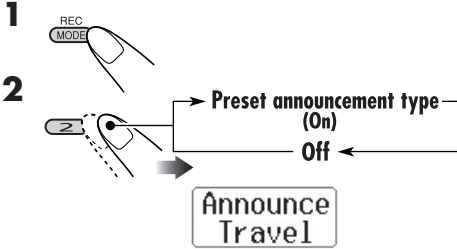

The ANN indicator either lights up or flashes

- If the ANN indicator lights up, Announcement Standby Reception is activated.
- If the ANN indicator flashes, Announcement Standby Reception is not yet activated. To activate, tune in to another service providing the signals. The ANN indicator will stop flashing and remain lit.

Tracking the same programme

You can keep listening to the same programme by activating the Alternative Frequency Reception (see page 89).

- **While receiving a DAB service:** When driving in an area where a service cannot be received, this receiver automatically tunes in to another ensemble or FM RDS station, broadcasting the same programme.

- **While receiving an FM RDS station:** When driving in an area where a DAB service is broadcasting the same programme as the FM RDS station is broadcasting, this receiver automatically tunes in to the DAB service.

When shipped from the factory, Alternative Frequency Reception is activated.

To deactivate the Alternative Frequency Reception, see page 89.

Changing the display information

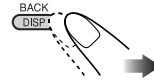

Ensemble name is enlarged.



Service name is enlarged.



DLS (Dynamic Label Segment: DAB text information) is displayed, being enlarged.

Maintenance

How to clean the connectors

Frequent detachment will deteriorate the connectors.

To minimize this possibility, periodically wipe the connectors with a cotton swab or cloth moistened with alcohol, being careful not to damage the connectors.

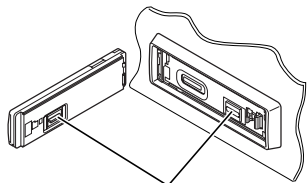

Connector

Moisture condensation

Moisture may condense on the lens inside the DVD/CD player in the following cases:

- After starting the heater in the car.
- If it becomes very humid inside the car.

Should this occur, the DVD/CD player may malfunction. In this case, eject the disc and leave the receiver turned on for a few hours until the moisture evaporates.

How to handle discs

When removing a disc from its case, press down the center holder of the case and lift the disc out, holding it by the edges.

Center holder



- Always hold the disc by the edges. Do not touch its recording surface.

When storing a disc into its case, gently insert the disc around the center holder (with the printed surface facing up).

- Make sure to store discs into the cases after use.

To keep discs clean

A dirty disc may not play correctly. If a disc does become dirty, wipe it with a soft cloth in a straight line from center to edge.



- Do not use any solvent (for example, conventional record cleaner, spray, thinner, benzene, etc.) to clean discs.

To play new discs

New discs may have some rough spots around the inner and outer edges. If such a disc is used, this receiver may reject the disc.



To remove these rough spots, rub the edges with a pencil or ball-point pen, etc.

Do not use the following discs:



Language codes

Code	Language	Code	Language	Code	Language
AA	Afar	IN	Indonesian	RO	Rumanian
AB	Abkhazian	IS	Icelandic	RU	Russia
AF	Afrikaans	IW	Hebrew	RW	Kinyarwanda
AM	Ameharic	JA	Japan	SA	Sanskrit
AR	Arabic	JI	Yiddish	SD	Sindhi
AS	Assamese	JW	Javanese	SG	Sangho
AY	Aymara	KA	Georgian	SH	Serbo-Croatian
AZ	Azerbaijani	KK	Kazakh	SI	Singhalese
BA	Bashkir	KL	Greenlandic	SK	Slovak
BE	Byelorussian	KM	Cambodian	SL	Slovenian
BG	Bulgarian	KN	Kannada	SM	Samoan
BH	Bihari	KO	Korean (KOR)	SN	Shona
BI	Bislama	KS	Kashmiri	SO	Somali
BN	Bengali, Bangla	KU	Kurdish	SQ	Albanian
BO	Tibetan	KY	Kirghiz	SR	Serbian
BR	Breton	LA	Latin	SS	Siswati
CA	Catalan	LN	Lingala	ST	Sesotho
CO	Corsican	LO	Laothian	SU	Sundanese
CS	Czech	LT	Lithuanian	SW	Swahili
CY	Welsh	LV	Latvian, Lettish	TA	Tamil
DZ	Bhutani	MG	Malagasy	TE	Telugu
EL	Greek	MI	Maori	TG	Tajik
EO	Esperanto	MK	Macedonian	TH	Thai
ET	Estonian	ML	Malayalam	TI	Tigrinya
EU	Basque	MN	Mongolian	TK	Turkmen
FA	Persian	MO	Moldavian	TL	Tagalog
FI	Finnish	MR	Marathi	TN	Setswana
FJ	Fiji	MS	Malay (MAY)	TO	Tonga
FO	Faroese	MT	Maltese	TR	Turkish
FY	Frisian	MY	Burmese	TS	Tsonga
GA	Irish	NA	Nauru	TT	Tatar
GD	Scots Gaelic	NE	Nepali	TW	Twì
GL	Galician	NO	Norwegian	UK	Ukrainian
GN	Guarani	OC	Occitan	UR	Urdu
GU	Gujarati	OM	(Afan) Oromo	UZ	Uzbek
HA	Hausa	OR	Oriya	VI	Vietnamese
HI	Hindi	PA	Panjabi	VO	Volapuk
HR	Croatian	PL	Polish	WO	Wolof
HU	Hungarian	PS	Pashto, Pushto	XH	Xhosa
HY	Armenian	PT	Portuguese	YO	Yoruba
IA	Interlingua	QU	Quechua	ZH	China
IE	Interlingue	RM	Rhaeto-Romance	ZU	Zulu
IK	Inupiak	RN	Kirundi		

More about the functions

Navigation System

Entering your destination

By the points of interests (P.O.I.)

- If no P.O.I. data exists for the selected city, "NO P.O.I. FOUND" appears on the display. Press **BACK (DISP)** until the CITY entry menu appears, then re-enter another city.

Selecting P.O.I. by area

- If no P.O.I. data exists for the selected area, "NO P.O.I. FOUND" appears on the display. Press **BACK (DISP)** until the main categories list appears.

By the coordinates

- If the entered position is out of navigable area, "NO NAVIGABLE AREA" appears on the display. Enter again.

Setting the route options

- Motorways are always used to calculate the route if the distance to the destination is over 200 km.
- If the destination cannot be reached without using motorways/ferries/tollroads, they are used to calculate the route without respect to the route option settings.

Convenient features using the stored routes

- If you try to display the stored addresses/routes when no addresses/routes have been stored, "ITEMS NOT FOUND" appears on the display.
- If you try to display the traffic information when no information is available, "ITEMS NOT FOUND" appears on the display.

Basic navigation processes

- If you turn off, then on the car ignition after starting the route guidance, it is restarted automatically following the screen below.

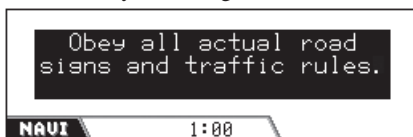

- If you try to enter a destination without the parking brake engaged, the following screen appears, and you cannot enter your destination.



- When you reach the area approximately within 30 m around the destination/Via Point, the Navigation System considers that you have reached your destination/Via Point.

Navigation guidance

- The System may not receive GPS signals in the following places...
 - in a tunnel or parking lot in the building
 - under an overhead road
 - in a place surrounded by high buildings or by closely standing trees.
- The position of your car may not be detected correctly in the following cases...
 - when running on a road close to the other one (e.g. a motorway and ordinary road running in parallel)
 - when turning at an almost straight fork in the road
 - when running on a gridiron road
 - after taking a ferry, etc.
 - when running on a steep mountain road
 - when running on a spiral road
 - when turning left or right after running on a long straight road

To be continued....

- when running in a zigzag line on a broad road
- when starting your car shortly after starting the engine
- when running for the first time after installing the unit
- when changing tires or attaching chains on the tires
- when tire slip occurs continuously and frequently
- after running on areas other than a road (e.g. private lands or parking lots)
- after running in underground or tower type parking lots
- after rotating your car on a turntable
- after frequent stops and starts in a congestion
- when the accuracy of GPS is deteriorated intentionally
- when running on a road constructed recently
- The route calculated by the System is one of the possible routes to your destination. The route is not always the most appropriate one.
- The following phenomena may occur even if the System is working correctly...
 - It may guide to a closed road.
 - It may guide to a route requiring U-turn.
 - It may not guide to your destination if there is only a narrow road or no road to your destination.
 - It may not avoid a congestion even if dynamic guidance is activated.
 - It may show a different road name.
 - It may not ask you to turn at a junction even if you need to.
 - It may give a guidance different from the actual road condition.
 - It may give an incorrect distance information.

Playback operations

Basic operations

- There is a time limit for some operations. In this case, if no further operation is done for a certain period, the current operation is cancelled.

Turning on the power

- By pressing **SOURCE** on the receiver, you can also turn on the power.

Selecting the sources

- When no disc is loaded in the receiver, “DISC” cannot be selected.
- Without connecting to the CD changer and DAB tuner, “CD-CH” and “DAB” cannot be selected.

Turning off the power

- If you turn off the power while listening to a disc, disc play will start automatically, next time you turn on the power.

Tuner operations

Storing stations in memory

- During SSM search...
 - All previously stored stations are erased and stations are stored newly.
 - Received stations are preset in No. 1 (lowest frequency) to No. 6 (highest frequency).
 - When SSM is over, the station stored in No. 1 will be automatically tuned in.
- When storing a station manually, a previously preset station is erased when a new station is stored in the same preset number.
- TA Standby Reception and PTY Standby Reception will be cancelled temporarily in the following cases:
 - While recording a CD into the HDD.
 - While editing the HDD contents.
 - While copying the SD contents into the HDD.
- If you want to know more about RDS, visit <<http://www.rds.org.uk>>.

Disc operations

General

- In this manual, words “track/file” and “folder/album” are interchangeably used when referring to MP3/WMA files and folders.
- On some discs, the actual operations may be different from what is explained in this manual.
- This receiver can also play back 8 cm discs.
- This receiver can only play back audio CD (CD-DA) files if different type of files are recorded in the same disc.
 - The first track will be skipped if a different type of file is detected first.
- For DVD-R/DVD-RW: This receiver can play only discs recorded in the DVD-Video format. (Discs recorded in the DVD-VR format cannot be played.)
- When a disc has been loaded, selecting “DISC” for the playback source starts disc play.

Inserting a disc

- When a disc is inserted upside down, the disc will eject automatically.

Basic operations

- No sound comes out during slow motion playback. When playing a VCD, reverse slow motion playback is prohibited.
- One Touch Replay works only within the same title. (For some DVDs, this function does not work.)
- When playing a DVD/VCD, no sound comes out during Search.
- Reverse search stops automatically when it reaches the beginning of the disc. Playback resumes at normal speed.

Playing a DVD-R/RW or CD-R/RW

- Use only “finalized” DVD-R/RWs or CD-R/RWs.
- If no playable files are recorded in a folder, the folder will not be recognized.
- This receiver can play back multi-session discs; however, unclosed sessions will be skipped while playing.
- Some DVD-R/RWs or CD-R/RWs may not play back on this receiver because of their disc characteristics, and for the following causes:
 - Discs are dirty or scratched.
 - Moisture condensation occurs on the lens inside the receiver.
 - The pickup lens inside the receiver is dirty.
 - CD-R/RWs on which the files are written with “Packet Write” method.
 - DVD-R/RWs which are not written in UDF-Bridge Format (ex. UDF format or ISO format).
 - There are improper recording conditions (missing data, etc.) or media conditions (stain, scratch, warp, etc.).
- DVD-RWs or CD-RWs may require a longer readout time since the reflectance of DVD-RW and CD-RW is lower than that of regular discs.
- Do not use the following DVD-R/RWs or CD-R/RWs:
 - Discs with stickers, labels, or protective seal stuck to the surface.
 - Discs on which labels can be directly printed by an ink jet printer.
 Using these discs under high temperatures or high humidities may cause malfunctions or damages to discs.

To be continued...

Playing MP3/WMA files

- This receiver can play back MP3/WMA files with the extension code <.mp3> or <.wma> (regardless of the letter case—upper/lower).
- This receiver can show the names of albums, artists (performer), and ID3 Tag (Version 1.0, 1.1, 2.2, 2.3, or 2.4) for MP3 files and for WMA files.
- This receiver can display only one-byte characters. No other characters can be correctly displayed.
- This receiver can play back MP3/WMA files meeting the conditions below:
 - Bit rate:
 - 32 kbps — 320 kbps (MP3)
 - 32 kbps — 192 kbps (WMA)
 - Sampling frequency:
 - 48 kHz, 44.1 kHz, 32 kHz (for MPEG-1/WMA)
 - 24 kHz, 22.05 kHz, 16 kHz (for MPEG-2)
 - Disc format: ISO 9660 Level 1/ Level 2, Romeo, Joliet, Windows long file name
- The maximum number of characters for file/folder names vary among the disc format used (includes 4 extension characters—<.mp3> or <.wma>).
 - ISO 9660 Level 1: up to 12 characters
 - ISO 9660 Level 2: up to 31 characters
 - Romeo: up to 128 characters
 - Joliet: up to 64 characters
 - Windows long file name: up to 128 characters
- This receiver can recognize the total of 1100 files and of 250 folders (maximum of 999 per folder).

- This receiver can play back the files recorded in VBR (variable bit rate).
The files recorded in VBR have a discrepancy in elapsed time display, and do not show the actual elapsed time. Especially, after performing the search function, this difference becomes noticeable.
- This receiver cannot play back the following MP3/WMA files:
 - MP3 files encoded in MP3i and MP3 PRO format.
 - MP3 files encoded in an unappropriated format.
 - MP3 files encoded with Layer 1/2.
 - WMA files encoded with lossless, professional, and voice format.
 - WMA files which are not based upon Windows Media® Audio.
 - WMA files copy-protected with DRM.
 - WMA files encoded with MBR (Multiple Bit Rate) format.
 - Files which have the data such as WAVE, ATRAC3, etc.

Changing the source

- If you change the source, playback also stops (without ejecting the disc).
Next time you select “DISC” for the playback source, disc play starts automatically.

Ejecting a disc

- If the ejected disc is not removed within 15 seconds, the disc is automatically inserted again into the loading slot to prevent it from dust. (Disc play will not start automatically.)

DVD/VCD special functions

- For some DVDs and VCDs, changing the subtitle language, audio language (or audio channel) without using the disc menu is prohibited.
- While zoomed in, the picture may look coarse.

DVD setup menu

- When the language you have selected is not recorded on a disc, the original language is automatically used as the initial language. In addition, for some discs, the initial languages settings will not work as you set due to their internal disc programming.
- After changing any of the initial language settings, eject the disc and insert it (or another disc) again so that your setting takes effect.
- When you select “16:9” for a picture whose aspect ratio is 4:3, the picture slightly changes due to the process for converting the picture width.
- Even if “4:3 PAN SCAN” is selected, the screen size may become “4:3 LETTER BOX” with some DVDs. This depends on how they are recorded.

HDD operations

Playing Playlists

- You can use the playback mode—Repeat Play, Random Play, or Intro Scan during playlist playback. However, when you start playlist playback (or change the playlist), the playback mode is cancelled. You need to select the playback mode again.
- If you have changed the genre name or album name or changed their locations after enrolling their tracks into a playlist, the tracks will be skipped when you play the playlist. (“No Music File” appears on the display.)

Recording audio CDs

- Sound quality may deteriorate if you select “Compress” for recording mode.
- While recording, recorded sounds are reproduced from the speakers. When recording is stopped, CD original sounds are reproduced.
- While recording, TA Standby Reception and PTY Standby Reception will be cancelled temporarily.
- While recording, you cannot change the playback source or eject the disc.

- Text data in the CD Text cannot be recorded into the HDD.
- If album recording is cancelled, the tracks which have been completely recorded will be stored into the HDD. Yet you cannot play back them until you finish recording the remaining. If you edit the HDD contents, eject the disc, or perform a new recording before recording the remaining, the recorded tracks will be discarded.
- Play time indication may advance unstably on the display while recording. This is not a malfunction of this unit.

Editing the HDD contents

- While playing a playlist, you cannot display the Edit menus.
- While editing, you cannot change the playback source or eject the disc.
- You cannot move a track or album if the same name exists in the target album or genre. In this case, “Same Name” appears.
- When you have selected “New Genre,” “New Album,” or “New Playlist” as a storage place (after recording or editing), its title will be assigned automatically such as <gexxxxx>, <alxxxxx>, or <plxvxxx.m3u>. You can change the title later manually (see page 72).
- You cannot use a space for the first character of the title when assigning it to album/genre/playlist.

SD operations

- The maximum number of characters for album/track name is 128 (including 4 extension code—<.mp3> or <.wma>).
- The required SD recording format is FAT 12/16/32 and the recommended storage type is 8 MB to 512 MB.
- You cannot use MMC or mini SD with this receiver.
- When an SD card is inserted, a file named “FAILSAFE” is automatically created in the card. The data size of this file varies among the inserted card.

- While playing an SD card, the playback order may differ from the one played back using other SD players.
- This receiver may be unable to play back some SD cards due to their characteristics or recording conditions.
- While duplicating SD data into HDD, you cannot change the playback source or eject the disc.

Sound adjustments

- While editing the HDD contents or duplicating SD into the HDD, you cannot make sound adjustments.

General settings—PSM

- While editing the HDD contents or duplicating SD into the HDD, you cannot enter the PSM setting screen.
- When you change the “DAB AF” setting from “Off” to “On,” the “AF-Regn'l” setting changes to “AF” if it has been set to “Off.”
- If you change the “Amp Gain” setting from “High Pwr” to “Low Pwr” while the volume level is set higher than “Volume 30,” the receiver automatically changes the volume level to “Volume 30.”

Other main functions

- If you try to assign a title to a 31st disc, “Name Full” flashes on the display. Delete unwanted titles before assignment.
- Titles assigned to discs in the CD changer can also be shown if you play back the disc in the receiver.

Glossary

Navigation System

DST

Stands for destination for this Navigation System.

ETA

Estimated Time of Arrival.

GPS

Global Positioning System.

By receiving the GPS signals from the satellites, the Navigation System determines the position of the car.

P.O.I.

Points of Interest.

You can select your destinations by selecting from the categories—such as business centres, shopping centres.

TMC

Traffic Message Channel.

Traffic messages transmitted by some VHF broadcasters via RDS signals.

Using this data, the Navigation System performs dynamic navigation.

Via Point

A location through which you reach your final destination. For this Navigation System, you can determine five locations through which you can reach your final destination.

Playback sources

Dolby Digital

Compressed digital audio, developed by Dolby Laboratories, which enables multi-channel encode to create the realistic surround sound.

DTS

Compressed digital audio, developed by Digital Theater Systems, Inc., which enables multi-channel like Dolby Digital. As the compression ratio is lower than for Dolby Digital, it provides wider dynamic range and better separation.

Linear PCM

Uncompressed digital audio, the same format used for CDs and most studio masters.

MPEG Audio

Another compressed digital audio which also enables multi-channel encode to create the realistic surround sound.

On-screen guide

While operating the built-in DVD/CD player, operation modes are displayed on the monitor. See the next column.

Playlist

A file that determines the playback sequence of the audio files stored in the HDD.

UDF-Bridge Format

A hybrid file system used to provide compatibility with ISO 9660 for accessing any type of files on the disc. (UDF stands for Universal Disk Format.)









WMA

Windows Media Audio.

A compression process developed by Microsoft® for compressing audio data (i.e. music).

On-screen guide icons

During play, the following guide icons may appear for a while on the monitor.

-  : Appears at the beginning of a scene containing multi-subtitle languages (for DVD only).
-  : Appears at the beginning of a scene containing multi-audio languages (for DVD only).
-  : Appears at the beginning of a scene containing multi-angle views (for DVD only).
-  : Playback
-  : Pause
-  : Forward slow motion playback (for DVD and VCD only)
-  : Reverse slow motion playback (for DVD only)
-  : Forward search
-  : Reverse search

Output signals through the DIGITAL OUT terminal

They differ depending on the “DIGITAL AUDIO OUTPUT” setting on the Setup Menu (see page 61).

- No signals come out while playing the files in the HDD or SD, or while recording an audio CD into the HDD.

DIGITAL AUDIO OUTPUT		Output Signals		
		STREAM/PCM	DOLBY DIGITAL/PCM	PCM ONLY
DVD	48 kHz, 16/20/24 bits Linear PCM	48 kHz, 16 bits stereo Linear PCM		
	96 kHz, Linear PCM			
	with DTS	DTS bitstream	48 kHz, 16 bits stereo Linear PCM	
	with Dolby Digital	Dolby Digital bitstream		48 kHz, 16 bits stereo Linear PCM
	with MPEG Audio	MPEG bitstream	48 kHz, 16 bits Linear PCM	
Audio CD, Video CD		44.1 kHz/48 kHz, 16 bits stereo Linear PCM		
Audio CD with DTS		DTS bitstream	44.1 kHz, 16 bits stereo Linear PCM	
MP3/WMA		32/44.1/48 kHz, 16 bits Linear PCM		

Troubleshooting

What appears to be trouble is not always serious. Check the following points before calling a service center.

Navigation troubles

	Symptoms	Causes	Remedies
General	<ul style="list-style-type: none"> Navigation voice cannot be heard from the speakers. 	Guidance voice level is set to the minimum level.	Adjust it to the optimum level.
	<ul style="list-style-type: none"> Navigation System does not work at all. 	The built-in microcomputer may have functioned incorrectly, etc.	Reset the unit (see page 2).
	<ul style="list-style-type: none"> “Low Temperature” appears and Navigation/Disc/HDD/SD do not work. 	The internal temperature is too low. This is normal. Internal protective circuitry is working.	Leave the power on, and wait until the internal temperature rises and the indication goes off.
	<ul style="list-style-type: none"> Navigation information is not precise. 	GPS antenna is affected by the windshield if installed in the car compartment.	Install the GPS antenna outside to avoid interference.
	<ul style="list-style-type: none"> Mechanical noises are heard. 	The HDD is constantly rotating at a high speed when the car ignition switch is on, causing imperceptible mechanical noise (especially when the temperature is low).	This is normal.
Destination setting	<ul style="list-style-type: none"> “NO P.O.I. FOUND” appears on the display. 	There are no matching points in your selected city or area.	Find the location using another method.
	<ul style="list-style-type: none"> “NO NAVIGABLE AREA” appears on the display. 	The entered point is out of the navigable area.	Enter a point within the navigable area.
		You have tried to save the current address into the STORED ADDRESS (see page 32) while you are out of the navigable area.	This is normal. You cannot save the current address if it is located out of the navigable area.

	Symptoms	Causes	Remedies
Destination setting	<p>“TOO MANY POIs. PLEASE INPUT DETAIL CATEGORY/CITY” appears on the display.</p>	Category/city you have selected includes too many POIs.	Specify the category/city more in details so that P.O.I. search becomes possible.
	<ul style="list-style-type: none"> • “TOO FAR FROM STREET” appears on the display. 	You have tried to save the current address into the STORED ADDRESS (see page 32) while you are about 300 m away from the nearest street.	This is normal. You can only save the current address when you are within 300 m from the street.
Guidance	<ul style="list-style-type: none"> • Navigation guidance is incorrect. 	Installation angle setting is not correct.	Installation angle setting affects the accuracy. Set it correctly (see page 21).
	<ul style="list-style-type: none"> • Navigation guidance is sometimes incorrect. 	Reversing signal/speed signal wires are not connected.	Connect them correctly (see Installation/Connection Manual—separate volume).
	<ul style="list-style-type: none"> • Navigation guidance is heard to listen to. 	Surround noise interferes.	Increase the voice cruise level (see page 20).

Receiver troubles

	Symptoms	Causes	Remedies
General	<ul style="list-style-type: none"> • “Push Reset” appears on the display, and the control panel movement is frozen. 	Something is blocking the control panel movement.	Remove the obstacle, then reset the receiver (see page 2). <ul style="list-style-type: none"> • If this does not work, check if the installation has been correctly done.
	<ul style="list-style-type: none"> • Sound cannot be heard from the speakers. 	The volume level is set to the minimum level.	Adjust it to the optimum level.
		Connections are incorrect.	Check the cords and connections.
	<ul style="list-style-type: none"> • The receiver does not work at all. 	The built-in microcomputer may have functioned incorrectly due to noise, etc.	Reset the receiver (see page 2).
FM/AM	<ul style="list-style-type: none"> • SSM automatic presetting does not work. 	Signals are too weak.	Store stations manually.
	<ul style="list-style-type: none"> • Static noise while listening to the radio. 	The antenna is not connected firmly.	Connect the antenna firmly.
Disc playback	<ul style="list-style-type: none"> • Disc cannot be recognised—“No Disc,” “Loading Error,” or “Eject Error” flashes. 	The DVD/CD player may have functioned incorrectly.	Eject the disc forcibly (see page 4).
	<ul style="list-style-type: none"> • “REGION CODE ERROR!” appears on the monitor. 	Disc with an incorrect Region Code is inserted.	Insert a disc with a proper Region Code (see page 6).
	<ul style="list-style-type: none"> • DVD-R/RW or CD-R/RW cannot be played back. • Tracks on the DVD-R/RW or CD-R/RW cannot be skipped. 	Disc is not finalized.	<ul style="list-style-type: none"> • Insert a finalized disc. • Finalize the disc with the component which you used for recording.
		<ul style="list-style-type: none"> • Disc can be neither played back nor ejected. 	The DVD/CD player may have functioned incorrectly
	<ul style="list-style-type: none"> • Disc sound and picture are sometimes interrupted. 	You are driving on rough roads.	Stop playback while driving on rough roads.
		Disc is scratched.	Change the disc.
Connections are incorrect.		Check the cords and connections.	

	Symptoms	Causes	Remedies
Disc playback	• No playback picture (DVD/VCD) appears on the monitor.	Parking brake wire is not connected properly.	See Installation/Connection Manual.
	• The left and right edges of the picture are missing on the screen.	“4:3 PAN SCAN” is selected when viewing on a conventional TV (aspect ratio 4:3).	Select “4:3 LETTER BOX.” (See page 60.)
MP3/WMA playback	• Disc cannot be played back.	No MP3/WMA tracks are recorded on the disc.	Change the disc.
		MP3/WMA tracks do not have the extension code <.mp3> or <.wma>.	Add the extension code <.mp3> or <.wma> to their file names.
		Tracks are not recorded in the format compliant with ISO 9660 Level 1, Level 2, Romeo, or Joliet.	Change the disc. (Record MP3/WMA tracks using a compliant application.)
	• Noise is generated.	The track played back is not an MP3/WMA file (although it has the extension code <.mp3> or <.wma>).	Skip to another track or change the disc. (Do not add the extension code <.mp3> or <.wma> to non-MP3 or WMA tracks.)
	• A longer readout time is required.	Readout time varies due to the complexity of the folder/file configuration.	Do not use too many hierarchies and folders.
	• Tracks cannot be played back as you have intended them to play.	Playback order is determined when the files are recorded.	_____
	• Elapsed playing time is not correct.	This sometimes occurs during play. This is caused by how the tracks are recorded on the disc.	_____
	• WMA track cannot be played back, and skipped.	The track is copy-protected with DRM.	_____
• Correct characters are not displayed (e.g. album name).	This receiver can only display alphabets (A – Z, a – z), numbers, and a limited number of symbols and some accented letters.	_____	

To be continued....

	Symptoms	Causes	Remedies
HDD/SD	• “No Files” appears on the display.	No playable file is recorded. Folder configuration is not correct.	Record using the correct folder configuration. See page 78.
	• “Read Failed” appears on the display.	SD card format is not appropriate. SD card or tracks cannot be played back.	Use SD card formatted in FAT 12/16/32. Reinsert or change the SD card.
	• “Invalid Card” appears on the display.	MMC card is inserted.	Use the SD card.
	• “No Music Files” appears on the display, and the folder is skipped.	No track is recorded in the selected folder (album/genre).	
	• “HDD Full,” “SD Full,” “Track Full,” “Album Full,” “Genre Full,” or “Playlist Full” appears on the display	The capacity of the target storage you have selected—such as HDD, SD, etc. is already full.	Deleting the unwanted items in the target storage to make an enough space.
	• “Cannot Recording” appears on the display.	You have tried to record any disc other than audio CDs.	
	• “Rec Error” appears and CD recording is cancelled.	Recording is failed due to the external influences such as vibration, shaking of the car	Stop recording on a rough road. Try to record once more while driving on a paved road. If the trouble still persist, consult your dealer.
	• “SCMS Cannot Copy” appears.	You have tried to copy non-original disc.	The second generation copy is prohibited. Copy its original disc.
	• You cannot move a track or an album (“Same Name” appears on the display).	The same named track or album exists in the target folder.	Select another target folder (album or genre).

	Symptoms	Causes	Remedies
HDD/SD	<ul style="list-style-type: none"> • “SD Loading Error” appears on the display. (You cannot open the control panel.) 	SD card is not fully inserted into the loading slot.	Insert it fully into the loading slot.
	<ul style="list-style-type: none"> • “Write Protect” appears on the display. 	SD card is write-protected.	Unprotect the SD by sliding the protect tab on the SD from the “LOCK” position to the opposite.
	<ul style="list-style-type: none"> • “No SD Card” appears on the display. 	SD card is not inserted.	Insert an SD card.
CD changer	<ul style="list-style-type: none"> • “No Disc” appears on the display. 	No disc is in the magazine.	Insert disc into the magazine.
		Disc is inserted upside down.	Insert disc correctly.
	<ul style="list-style-type: none"> • “No Magazine” appears on the display. 	No magazine is loaded in the CD changer.	Insert the magazine.
	<ul style="list-style-type: none"> • “Reset 8” appears on the display. 	This receiver is not connected to the CD changer correctly.	Connect this receiver and the CD changer correctly and press the reset button of the CD changer.
	<ul style="list-style-type: none"> • “Reset 1” – “Reset 7” appears on the display. 	—————	Press the reset button of the CD changer.
	<ul style="list-style-type: none"> • The CD changer does not work at all. 	The built-in microcomputer may function incorrectly due to noise, etc.	Reset the receiver (see page 2).

Specifications

NAVIGATION SYSTEM

System & Service:

- L1, C/A code
- Global Positioning System
- Standard Positioning Service

Reception System: 15-channel multi-channel reception system

Reception Frequency: 1 575.42 MHz

Sensitivity: -130 dBm

Update Rate: 1/second, continuous

[GPS Antenna]

Polarization: Right Handed Circular Polarization

Dimensions (approx.):

30.4 mm × 11.7 mm × 35.5 mm (W × H × D)

Cable (approx.): 5.0 m

Attachment mat size (approx.): 70 mm × 70 mm

AUDIO AMPLIFIER SECTION

Maximum Power Output:

Front: 50 W per channel

Rear: 50 W per channel

Continuous Power Output (RMS):

Front: 20 W per channel into 4 Ω, 40 Hz to 20 000 Hz at no more than 0.8% total harmonic distortion.

Rear: 20 W per channel into 4 Ω, 40 Hz to 20 000 Hz at no more than 0.8% total harmonic distortion.

Load Impedance: 4 Ω (4 Ω to 8 Ω allowance)

Equalizer Control Range:

Frequencies: 60 Hz, 150 Hz, 400 Hz, 1 kHz, 2.4 kHz, 6 kHz, 12 kHz

Level: ±10 dB

Signal-to-Noise Ratio: 70 dB

Audio output level:

Digital (DIGITAL OUT: Optical):

Signal wave length: 660 nm

Output level: -21 dBm to -15 dBm

Line-Out Level/Impedance:

2.0 V/20 kΩ load (full scale)

Output Impedance: 1 kΩ

Color system: PAL

Video output (composite): 1 Vp-p/75 Ω

Other Terminals: SUBWOOFER OUT,

CD changer

Steering wheel remote input

TUNER SECTION

Frequency Range:

FM: 87.5 MHz to 108.0 MHz

AM: (MW) 522 kHz to 1 620 kHz
(LW) 144 kHz to 279 kHz

[FM Tuner]

Usable Sensitivity: 11.3 dBf (1.0 μV/75 Ω)

50 dB Quieting Sensitivity:

16.3 dBf (1.8 μV/75 Ω)

Alternate Channel Selectivity (400 kHz): 65 dB

Frequency Response: 40 Hz to 15 000 Hz

Stereo Separation: 40 dB

Capture Ratio: 1.5 dB

[MW Tuner]

Sensitivity: 20 μV

Selectivity: 65 dB

[LW Tuner]

Sensitivity: 50 μV

DVD/CD PLAYER SECTION

Signal Detection System: Non-contact optical pickup (semiconductor laser)

Number of Channels: 2 channels (stereo)

Frequency Response:

DVD, fs=48 kHz/96 kHz:

16 Hz to 20 000 Hz

VCD/CD: 16 Hz to 20 000 Hz

Dynamic Range: 96 dB

Signal-to-Noise Ratio: 98 dB

Wow and Flutter: Less than measurable limit

MP3 (MPEG Audio Layer 3):

Max. Bit Rate: 320 Kbps

WMA (Windows Media® Audio):

Max. Bit Rate: 192 Kbps

HDD/SD SECTION

MP3 (MPEG Audio Layer 3):

Max. Bit Rate: 320 kbps

WMA (Windows Media® Audio):

Max. Bit Rate: 192 kbps

GENERAL

Power Requirement:

Operating Voltage:

DC 14.4 V (11 V to 16 V allowance)

Grounding System: Negative ground

Allowable Operating Temperature:

0°C to +40°C

Allowable Operating Altitude:

-300 m to +3000 m

Dimensions (W × H × D):

Installation Size (approx.):

182 mm × 52 mm × 159 mm

Panel Size (approx.):

188 mm × 58 mm × 13 mm

Mass (approx.): 2.1 kg (excluding accessories)

Design and specifications are subject to change without notice.

- Microsoft and Windows Media are either registered trademarks or trademarks of Microsoft Corporation in the United States and/or other countries.
- This unit is not compatible with Multiple Bit Rate (MBR: a file that contains the same content encoded at several different bit rates).

The digitised maps for this Navigation System supplied by NAVTEQ Corporation are all copyrighted in the following countries:

Austria:	© Bundesamt für Eich- und Vermessungswesen
France:	source: Géoroute® IGN France & BD Carto® IGN France
Germany:	Die Grundlagendaten wurden mit Genehmigung der zuständigen Behörden entnommen
Italy:	La Banca Dati Italiana è stata prodotta usando quale riferimento anche cartografia numerica ed al tratto prodotta e fornita dalla Regione Toscana
Norway:	Copyright © 2000; Norwegian Mapping Authority
Portugal:	Source: IgeoE – Portugal
Spain:	Información geográfica propiedad del CNIG
Sweden:	Based upon electronic data © National Land Survey Sweden
Switzerland:	Topografische Grundlage: © Bundesamt für Landestopographie
UK:	Based upon Ordnance Survey electronic data and used with the permission of the Controller of Her Majesty's Stationary Office © Crown Copyright, 1995.

The receiver is equipped with the steering wheel remote control function.

- See the Installation/Connection Manual (separate volume) for connection.

This product incorporates copyright protection technology that is protected by U.S. patents and other intellectual property rights. Use of this copyright protection technology must be authorized by Macrovision, and is intended for home and other limited viewing uses only unless otherwise authorized by Macrovision. Reverse engineering or disassembly is prohibited.

END-USER LICENSE AGREEMENT

THIS END-USER LICENSE AGREEMENT (“AGREEMENT”) IS A BINDING LEGAL CONTRACT BETWEEN YOU (EITHER AN INDIVIDUAL OR A LEGAL ENTITY), ON THE ONE HAND, AND VICTOR COMPANY OF JAPAN, LIMITED (“JVC”) AND ITS LICENSORS (INCLUDING THEIR LICENSORS AND SUPPLIERS) ON THE OTHER HAND. BY USING THE DATA (“DATA”) AND SOFTWARE LICENSED UNDER THIS AGREEMENT (COLLECTIVELY, THE “PRODUCT”), YOU WILL BE BOUND BY THE TERMS OF THIS AGREEMENT. IF YOU DO NOT AGREE TO THE TERMS OF THIS AGREEMENT, JVC AND ITS LICENSORS ARE NOT WILLING TO LICENSE ANY RIGHT TO USE OR ACCESS THE PRODUCT TO YOU.

The Product is provided for your personal, internal use only and not for resale or distribution to others. It is protected by copyright and other intellectual property laws, and is subject to the terms and conditions of this Agreement.

© 1993–2004 NAVTEQ All rights reserved.

The Data for areas of Canada includes information taken with permission from Canadian authorities, including: © Her Majesty the Queen in Right of Canada, © Queen’s Printer for Ontario, © Canada Post Corporation, GeoBase ®.

TERMS AND CONDITIONS

Personal Use Only. Subject to the terms and conditions of this Agreement, JVC and its licensors (including their licensors and suppliers), as appropriate, hereby grant you a non-transferable, non-exclusive license to use the Product together with JVC TBT Car Navigation Application Software for the solely personal, non-commercial purposes for which you were licensed, and not for service bureau, time-sharing or other similar purposes. You may only use the Product as described in this Agreement and with its accompanying documentation. Accordingly, but subject to the restrictions set forth in the following paragraphs, you may copy the Data only as necessary for your personal use to view and save the Data, provided that you do not remove any copyright or other proprietary notices that are associated with the Product and do not modify the Product in any way. You agree not to otherwise reproduce, copy, modify, decompile, disassemble or reverse engineer any portion of the Product, and not to sublicense, loan, transfer, distribute or sell it in any form, in whole or in part and for any purpose, except to the extent permitted by mandatory laws. Any software provided as part of the Product will be in object code form only and any copy of such software shall be used only as a back-up, provided that the primary and back-up copy may not be used concurrently. JVC and its licensors (including their licensors and suppliers) reserve the right to upgrade, enhance, change or modify the Product at any time in its sole discretion (“Enhancements”). Any Enhancements made available to you, if any, will be subject to the terms of this Agreement, except to the extent that conflicting or more restrictive provisions are provided in future agreements relating to such Enhancements.

Restrictions. Except where you have been specifically licensed to do so by JVC, and without limiting the preceding paragraph, you (a) may not use the Product with any products, systems, or applications installed or otherwise connected to or in communication with vehicles, capable of vehicle navigation, positioning, dispatch, real time route guidance, fleet management or similar applications; (b) may not use the Product with or in communication with any positioning devices or any mobile or wireless-connected electronic or computer devices, including without limitation cellular phones, palmtop and handheld computers, pagers, and personal digital assistants or PDAs or any similar devices; and (c) shall maintain the Product in strict confidence and shall not disclose it or make it available to any unauthorized third parties. Without limiting the foregoing, you may only use the Data in the form delivered and it may not be subject to any further automated or systematic processing. You may transfer the license and all copies of the Product to a third party, provided that (i) the transferee agrees to comply with the terms and conditions of this Agreement and (ii) you irrevocably delete the Product from your systems, if applicable. Except for the limited license granted in this Agreement, JVC and its licensors (including their licensors and suppliers) retain all right, title and interest in the Product, all copies thereof, and all proprietary rights in the Product, including copyrights, patents, trademarks and trade secret rights.

No Warranty. The Product is provided to you “as is”, and you agree to use it at your own risk. JVC and its licensors (and their licensors and suppliers) make no guarantees, representations, conditions or warranties of any kind, express or implied, arising by law or otherwise, respecting the Product including but not limited to, content, quality, accuracy, completeness, effectiveness, reliability, fitness for a particular purpose, usefulness, use or results to be obtained from this Product, or that use of the Product or of the server from which the Data is accessed, if applicable, will be uninterrupted or error-free. You assume full responsibility for the selection of the Product to achieve your intended purpose, for the proper installation and use of the Product and verifying the results obtained from your use.

Disclaimer of Warranty: JVC AND ITS LICENSORS (INCLUDING THEIR LICENSORS AND SUPPLIERS) DISCLAIM ANY WARRANTIES, EXPRESS OR IMPLIED, OF QUALITY, PERFORMANCE, MERCHANTABILITY, FITNESS FOR A PARTICULAR PURPOSE OR NON-INFRINGEMENT. SOME STATES, TERRITORIES AND COUNTRIES DO NOT ALLOW CERTAIN WARRANTY EXCLUSIONS, SO TO THAT EXTENT THE ABOVE EXCLUSION MAY NOT APPLY TO YOU.

Disclaimer of Liability: JVC AND ITS LICENSORS (INCLUDING THEIR LICENSORS AND SUPPLIERS) SHALL NOT BE LIABLE TO YOU IN RESPECT OF ANY CLAIM, DEMAND OR ACTION, IRRESPECTIVE OF THE NATURE OF THE CAUSE OF THE CLAIM, DEMAND OR ACTION ALLEGING ANY LOSS, INJURY OR DAMAGES, DIRECT OR INDIRECT, WHICH MAY RESULT FROM THE USE OR POSSESSION OF THE PRODUCT; OR FOR ANY LOSS OF PROFIT, REVENUE, CONTRACTS OR SAVINGS, OR ANY OTHER DIRECT, INDIRECT, PUNITIVE, EXEMPLARY, INCIDENTAL, SPECIAL OR CONSEQUENTIAL DAMAGES ARISING OUT OR RELATING TO THIS AGREEMENT, YOUR USE OF OR INABILITY TO USE THE PRODUCT, ANY DEFECT IN THE PRODUCT, OR THE BREACH OF THESE TERMS OR CONDITIONS, WHETHER IN AN ACTION IN CONTRACT OR TORT OR BASED ON A WARRANTY OR OTHER LEGAL THEORY, EVEN IF JVC OR ITS LICENSORS (INCLUDING THEIR LICENSORS AND SUPPLIERS) HAVE BEEN ADVISED OF THE POSSIBILITY OF SUCH DAMAGES. IT IS EXPRESSLY UNDERSTOOD AND AGREED THAT IN THE EVENT ANY REMEDY HEREUNDER IS DETERMINED TO HAVE FAILED OF ITS ESSENTIAL PURPOSE, ALL LIMITATIONS OF LIABILITY AND EXCLUSIONS OF DAMAGES SET FORTH HEREIN SHALL REMAIN IN EFFECT. SOME STATES, TERRITORIES AND COUNTRIES DO NOT ALLOW CERTAIN LIABILITY EXCLUSIONS OR DAMAGES LIMITATIONS, SO TO THAT EXTENT THE ABOVE MAY NOT APPLY TO YOU.

Termination. This Agreement is effective until terminated. Your rights under this Agreement will terminate automatically without notice if you fail to comply with any of the terms and conditions of this Agreement. The following provisions shall survive any termination or expiration of this Agreement: No Warranty, Disclaimer of Liability, Indemnity, Entire Agreement, and Governing Law.

Export Control. You agree not to export from anywhere any part of the Product provided to you or any direct product thereof except in compliance with, and with all licenses and approvals required under, applicable export laws, rules and regulations.

Indemnity. You agree to indemnify, defend and hold JVC and its licensors (including their respective licensors, suppliers, assignees, subsidiaries, affiliated companies, and the respective officers, directors, employees, shareholders, agents and representatives of each of them) free and harmless from and against any claim, demand or action, irrespective of the nature of the claim, demand or action, alleging any liability, loss, injury (including injuries resulting in death), cost, expense, or damages of any kind or character, including but not limited to attorney’s fees, arising out of or in connection with any use or possession by you of this Product.

Entire Agreement. These terms and conditions constitute the entire Agreement between JVC and its licensors (including their licensors and suppliers) and you pertaining to the subject matter hereof, and supersede in its entirety any and all written or oral agreements previously existing between us with respect to such subject matter. This Agreement may not be modified, amended or in any way altered except by an instrument in writing signed by authorized representatives of both parties. In the event that any provision of this Agreement is found invalid or unenforceable pursuant to judicial decree, the remainder of this Agreement shall remain valid and enforceable according to its terms.

Warnings. The Data may contain inaccurate or incomplete information due to the passage of time, changing circumstances, sources used and the nature of collecting comprehensive geographic data, any of which may lead to incorrect results.

Governing Law. The above terms and conditions shall be governed by the laws of the Netherlands, without giving effect to (i) its conflict of laws provisions, or (ii) the United Nations Convention for Contracts for the International Sale of Goods, which is explicitly excluded. You agree to submit to the jurisdiction of The Netherlands for any and all disputes, claims and actions arising from or in connection with the Product provided to you hereunder.

U.S. Government End Users. If the Product is being acquired by or on behalf of the United States government or any other entity seeking or applying rights similar to those customarily claimed by the United States government, the Product is licensed in accordance with the rights set forth at DFARS 252.227-7013(f)(3), TECHNICAL DATA - NONCOMMERCIAL ITEMS; DFARS 227.7202 et seq., COMMERCIAL COMPUTER SOFTWARE OR COMMERCIAL COMPUTER SOFTWARE DOCUMENTATION; FAR 12.211, TECHNICAL DATA; and FAR 12.212, COMPUTER SOFTWARE, as applicable. Users shall have only the rights in the Product that have been referenced or specified in this Agreement.

In addition, (i) for acquisitions conducted by the Department of Defense, the Data is licensed with “Limited Rights” in accordance with the rights set forth at DFARS 252.227-7013(f)(3), TECHNICAL DATA – NONCOMMERCIAL ITEMS, and Data delivered or otherwise furnished with “Limited Rights” shall be marked with the following “Limited Rights Notice” set forth at DFARS 252.227-7013(f)(3), and shall be treated in accordance with such Notice:

LIMITED RIGHTS

CONTRACT NO.: _____

CONTRACTOR (MANUFACTURER/SUPPLIER) NAME: NAVTEQ

CONTRACTOR (MANUFACTURER/SUPPLIER) ADDRESS: 222 Merchandise Mart Plaza, Suite 900, Chicago, Illinois 60654

The Government’s rights to use, modify, reproduce, release, perform, display, or disclose these technical data are restricted by paragraph (b)(3) of the Rights in Technical Data - Noncommercial Items clause contained in the above identified contract. Any reproduction of technical data or portions thereof marked with this legend must also reproduce the markings. Any person, other than the Government, who has been provided access to such data must promptly notify the above named Contractor.

and; (ii) for civilian agency acquisitions, the Data is licensed in accordance with the rights set forth at FAR 52.227-14(g)(1), RIGHTS IN DATA - GENERAL (Protection of limited rights data and computer software). In the event that the Contracting Officer requires the delivery of limited rights data that has been withheld or would otherwise be withholdable in accordance with FAR 52.227-14(g)(1), the Data is licensed with “Limited Rights” as set forth in the following “Limited Rights Notice” at FAR 52.227-14(g)(2) (Alternate II), which shall be affixed to the Data and the Data shall be treated in accordance with such Notice (which shall be marked on any reproduction of these data, in whole or in part):

LIMITED RIGHTS NOTICE (JUN 1987)

These data are submitted with limited rights under Government Contract No. _____ (and subcontract _____, if appropriate). These data may be reproduced and used by the Government with the express limitation that they will not, without written permission of the Contractor, be used for purposes of manufacture nor disclosed outside the Government; except that the Government may disclose these data outside the Government for the following purposes, if any, provided that the Government makes such disclosure subject to prohibition against further use and disclosure: There are no additional purposes permitting disclosure of such Data.

The manufacturer/supplier of the Data is NAVTEQ, 222 Merchandise Mart Plaza, Suite 900, Chicago, Illinois 60654.

If the Contracting Officer refuses to comply with the applicable licenses set forth herein, the Contracting Officer must notify NAVTEQ prior to seeking additional or alternative rights in the Product.

**Having TROUBLE with operation?
Please reset your unit
Refer to page of How to reset your unit**

**Haben Sie PROBLEME mit dem Betrieb?
Bitte setzen Sie Ihr Gerät zurück
Siehe Seite Zurücksetzen des Geräts**

**Vous avez des PROBLÈMES de fonctionnement?
Réinitialisez votre appareil
Référez-vous à la page intitulée Comment réinitialiser votre appareil**

**Hebt u PROBLEMEN met de bediening?
Stel het apparaat terug
Zie de pagina met de paragraaf Het apparaat terugstellen**

JVC



ENGLISH

This unit is designed to operate only on **12 V DC, NEGATIVE ground electrical systems**. If your vehicle does not have this system, a voltage inverter is required, which can be purchased at JVC IN-CAR ENTERTAINMENT dealers.

- Read this manual carefully and thoroughly. Especially pay attention to the safety instructions.

WARNINGS

- DO NOT install any unit in locations where;
 - it may obstruct the steering wheel and gearshift lever operations, as this may result in a traffic accident.
 - it may obstruct the operation of safety devices such as air bags, as this may result in a fatal accident.
 - it may obstruct visibility.
- DO NOT operate any unit while manipulating the steering wheel, as this may result in a traffic accident.
- The driver must not watch the monitor while driving. If the driver watches the monitor while driving, it may lead to carelessness and cause an accident.
- If the parking brake is not engaged, the following messages appear...
 - When you try to watch the playback picture on the monitor, "DRIVER MUST NOT WATCH THE MONITOR WHILE DRIVING" appears, and no playback picture will be shown.
 - When you try to enter your destination for the navigation guidance, "Function not available while driving." appears, and you cannot enter the destination.
 These warnings appear only when the parking brake wire is not connected, or the parking brake is not engaged.

Before installing the unit, observe the following...

- Park the car in a safe and level place, and turn off the ignition switch.
- It is strictly recommended to have the unit installed by a technician who has special knowledge and skills for installation. Incorrect installation may result in damage to the unit or to the vehicle.
- Attach each component firmly in place so that it cannot be loosened or detached in the event of a collision or sudden braking.
- **Take preventive measures to avoid unexpected disconnection of the cords and damage to the cords. This trouble may happen while moving or reclining the seat.**

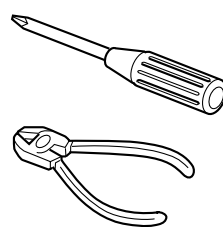

FRANÇAIS

Cet appareil est conçu pour fonctionner sur des sources de **courant continu de 12 V à masse NÉGATIVE** seulement. Si votre véhicule n'offre pas ce type d'alimentation, il vous faut un convertisseur de tension, que vous pouvez acheter chez un revendeur d'autoradios JVC.

- Lisez attentivement et complètement ce Manuel d'installation/raccordement. En faisant, particulièrement attention aux instructions de sécurité.

AVERTISSEMENTS

- **N'INSTALLEZ aucun appareil dans les endroits suivants:**
 - où il peut gêner l'accès au volant ou au levier de vitesse car cela peut entraîner un accident de la circulation.
 - où il peut gêner la manipulation de dispositifs de sécurité tels que les coussins de sécurité car cela peut entraîner un accident fatal.
 - où il peut gêner la visibilité.
- **NE COMMANDEZ PAS l'appareil lors de la manipulation du volant car cela peut entraîner un accident de la circulation.**
- **Le conducteur ne doit pas regarder le moniteur lorsqu'il conduit.** Se livrer à ce genre d'activité lorsqu'on est au volant réduit considérablement la vigilance du conducteur et multiplie les risques d'accident.
- **Si le frein de stationnement n'est pas engagé, le message suivant apparaît...**
 - Quand vous essayez de regarder l'image de lecture sur le moniteur, "LE CONDUCTEUR NE DOIT PAS REGARDER LE MONITEUR EN CONDUISANT" apparaît et aucune image de lecture n'est montrée.
 - Quand vous essayez d'entrer votre destination pour la navigation, "Cette fonction n'est pas accessible pendant la conduite" apparaît et vous ne pouvez pas entrer la destination. Ces avertissements apparaissent uniquement si le fil du frein de stationnement n'est pas connecté ou si le frein de stationnement n'est pas engagé.

Avant d'installer l'appareil, respectez les points suivant...

- **Garez la voiture dans un endroit sûr et plat et coupez le contact de la voiture.**
- **Il est strictement recommandé de faire installer l'appareil par un technicien qui possède des connaissances spéciales et des compétences pour l'installation. Une installation incorrecte peut entraîner des dommages à l'appareil ou au véhicule.**
- **Fixez solidement chaque appareil de façon qu'il ne puisse pas se desserrer ou se détacher même en cas de collision ou de coup de frein brutal.**
- **Prenez des mesures préventives pour éviter que des cordons se déconnectent accidentellement ou soient endommagés. Cela peut se produire lorsque vous déplacez ou inclinez le siège.**

Parts list for installation and connection

The following parts are provided for this unit.
After checking them, please set them correctly.

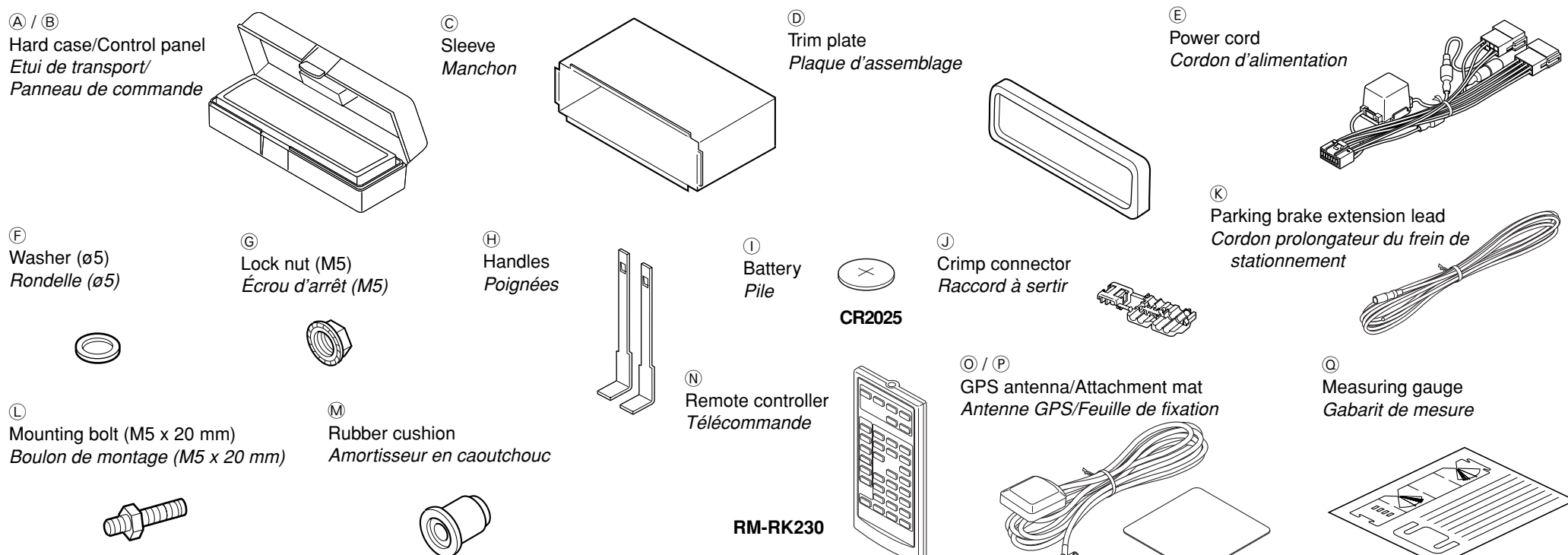

Liste des pièces pour l'installation et raccordement

Les pièces suivantes sont fournies avec cet appareil.
Après vérification, veuillez les placer correctement.

TROUBLESHOOTING

- **The fuse blows.**
 - * Are the red and black leads connected correctly?
- **Power cannot be turned on.**
 - * Is the yellow lead connected?
- **No sound from the speakers.**
 - * Is the speaker output lead short-circuited?
- **Sound is distorted.**
 - * Is the speaker output lead grounded?
 - * Are the "–" terminals of L and R speakers grounded in common?
- **Noise interfere with sounds.**
 - * Is the rear ground terminal connected to the car's chassis using shorter and thicker cords?
- **The receiver becomes hot.**
 - * Is the speaker output lead grounded?
 - * Are the "–" terminals of L and R speakers grounded in common?
- **The receiver does not work at all.**
 - * Have you reset the receiver?

EN CAS DE DIFFICULTÉS

- **Le fusible saute.**
 - * Les fils rouge et noir sont-ils raccordés correctement?
- **L'appareil ne peut pas être mise sous tension.**
 - * Le fil jaune est-il raccordé?
- **Pas de son des enceintes.**
 - * Le fil de sortie d'enceinte est-il court-circuité?
- **Le son est déformé.**
 - * Le fil de sortie d'enceinte est-il à la masse?
 - * Les bornes "–" des enceintes gauche et droite sont-elles mises ensemble à la masse?
- **Interférence avec les sons.**
 - * La prise arrière de mise à la terre est-elle connectée au châssis de la voiture avec un cordon court et épais?
- **L'autoradio devient chaud.**
 - * Le fil de sortie d'enceinte est-il à la masse?
 - * Les bornes "–" des enceintes gauche et droite sont-elles mises ensemble à la masse?
- **L'autoradio ne fonctionne pas du tout.**
 - * L'avez-vous réinitialisé?

INSTALLATION (IN-DASH MOUNTING)

The following illustration shows a typical installation. If you have any questions or require information regarding installation kits, consult your JVC IN-CAR ENTERTAINMENT dealer or a company supplying kits.

- If you are not sure how to install this unit correctly, have it installed by a qualified technician.
- Make sure not to block the fan on the rear panel to maintain proper ventilation when installed.

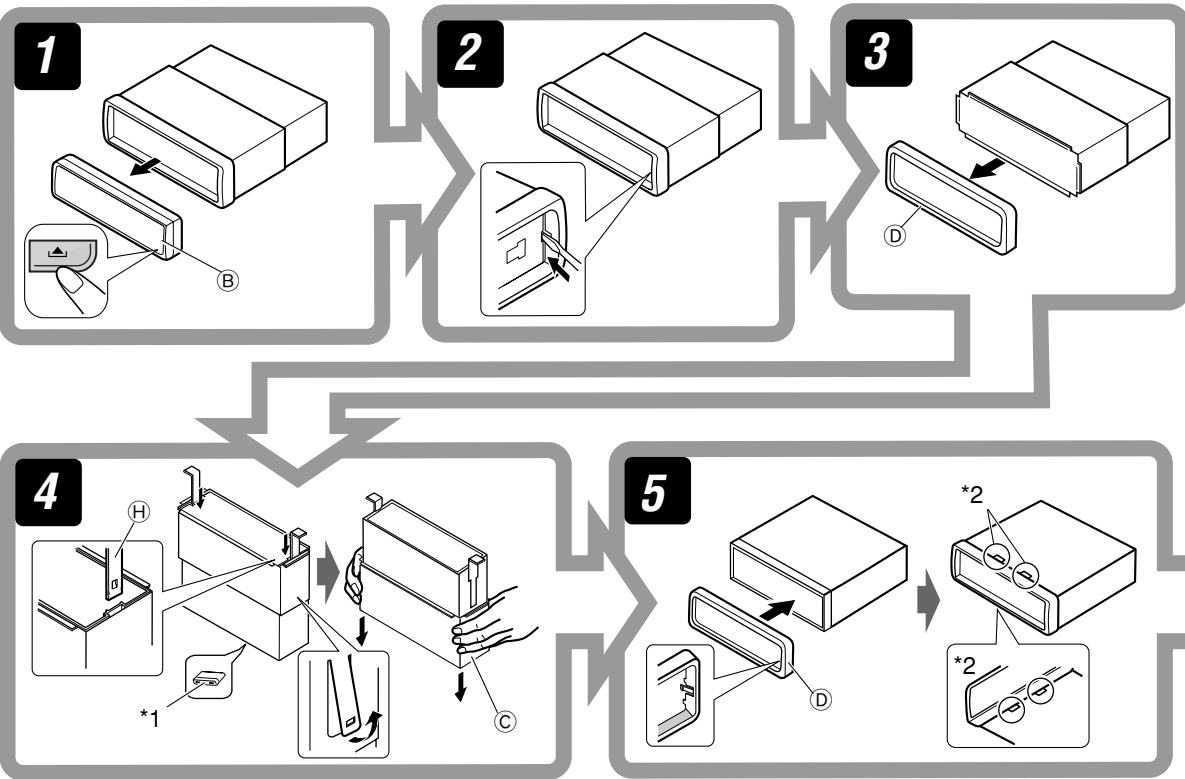

*1 When you stand the unit, be careful not to damage the fuse on the rear.

*1 Lorsque vous mettez l'appareil à la verticale, faire attention de ne pas endommager le fusible situé sur l'arrière.

INSTALLATION (MONTAGE DANS LE TABLEAU DE BORD)

L'illustration suivante est un exemple d'installation typique. Si vous avez des questions ou avez besoin d'information sur des kits d'installation, consultez votre revendeur d'autoradios JVC ou une compagnie d'approvisionnement.

- Si vous n'êtes pas sûr de pouvoir installer correctement cet appareil, faites-le installer par un technicien qualifié.
- Lors de l'installation assurez-vous de ne pas bloquer le ventilateur à l'arrière afin de permettre une ventilation correcte.

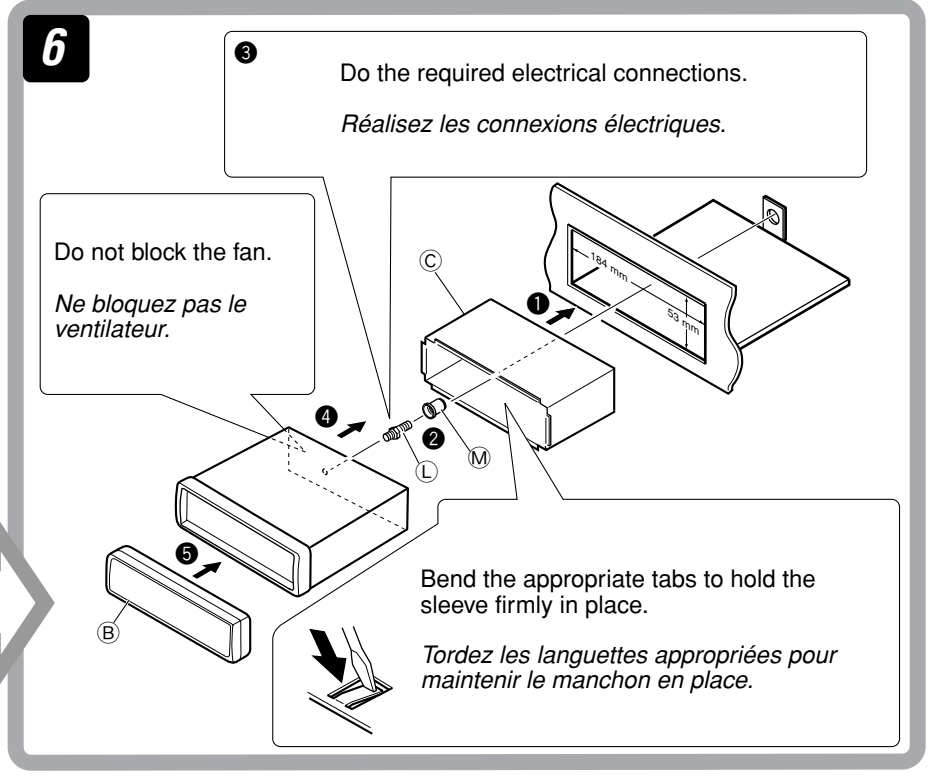

*2 Fit the protrusions outside the unit.

*2 Fixez les protubérances à l'extérieur de l'appareil.

Caution for installing

Fit the receiver into the mounting sleeve by using four corners of the trim plate.
• DO NOT press the panel (shaded in the illustration).

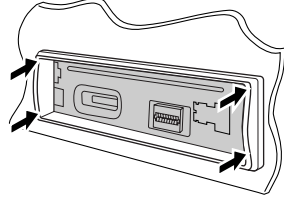

Précautions lors de l'installation

Fixez l'autoradio sur le manchon de montage en utilisant les quatre coins de la plaque de garniture.
• NE PUSSEZ PAS sur le panneau (en gris sur l'illustration).

Removing the unit

Before removing the unit, release the rear section.

Retrait de l'appareil

Avant de retirer l'appareil, libérer la section arrière.

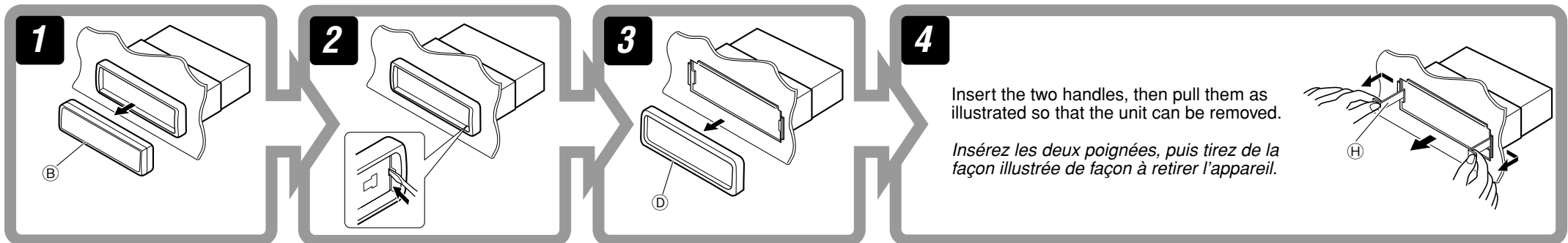

When using the optional stay Lors de l'utilisation du hauban en option

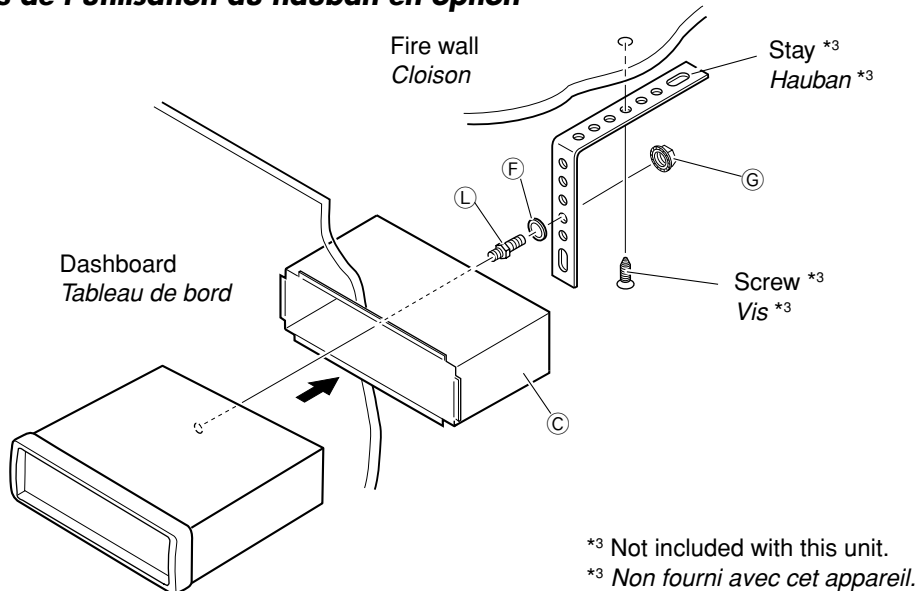

*3 Not included with this unit.
*3 Non fourni avec cet appareil.

When installing the unit without using the sleeve Lors de l'installation de l'appareil sans utiliser de manchon

In a Toyota for example, first remove the car radio and install the unit in its place.
Par exemple dans une Toyota, retirez d'abord l'autoradio et installez l'appareil à la place.

Flat type screws (M5 x 8 mm) *3
Vis à tête plate (M5 x 8 mm) *3

*3 Not included with this unit.
*3 Non fourni avec cet appareil.

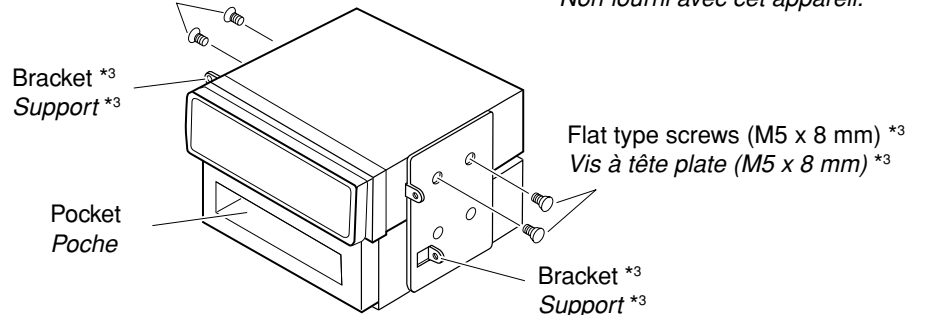

Note : When installing the unit on the mounting bracket, make sure to use the 8 mm-long screws. If longer screws are used, they could damage the unit.

Remarque : Lors de l'installation de l'appareil sur le support de montage, assurez-vous d'utiliser des vis d'une longueur de 8 mm. Si des vis plus longues sont utilisées, elles peuvent endommager l'appareil.

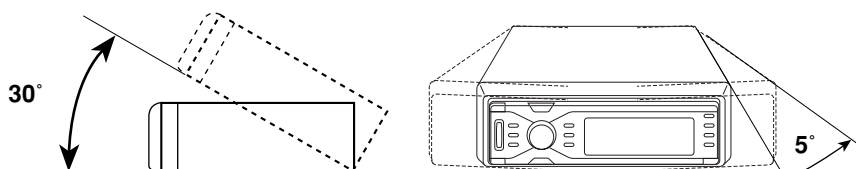

Install the unit at an angle of less than 30° vertically and of less than 5° horizontally.
• After installation, confirm the vertical angle of the unit using the supplied measuring gauge.

Installez l'appareil avec un angle vertical de moins de 30° et un angle horizontal de moins de 5°.
• Après l'installation, vérifiez l'angle vertical de l'appareil en utilisant le gabarit de mesure fourni.

Assembling the measuring gauge Assemblage du gabarit de mesure

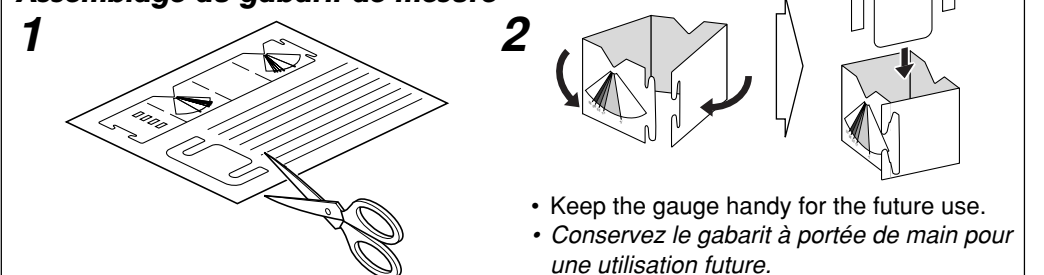

- Keep the gauge handy for the future use.
- Conservez le gabarit à portée de main pour une utilisation future.

Measuring the installation angle

BEFORE starting, make sure...

- You have parked the car where it cannot be inclined. (It should be parked horizontally.)

1

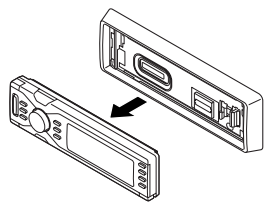

1 Detach the control panel.

2 Measure the angle.

- Attach the measuring gauge closely and flatly to the main unit (to the portion shaded in the above illustration).

3 Note your measured angle.

- ① → UNIT ANGLE 1 (-5.0 to 17.0°)
- ② → UNIT ANGLE 2 (17.0 to 23.0°)
- ③ → UNIT ANGLE 3 (23.0 to 28.0°)
- ④ → UNIT ANGLE 4 (28.0 to 32.0°*)

* It is not recommended to install the main unit at an angle of more than 30°; otherwise, the malfunction may result.

When you use the Navigation System for the first time after installation...

Follow the procedure described on pages 11 and 12 of the INSTRUCTIONS (separate volume).

Mesure de l'angle d'installation

AVANT de commencer, assurez-vous que...

- Vous avez garé votre voiture dans un endroit où elle n'est pas inclinée. (Elle doit être garée horizontalement).

2

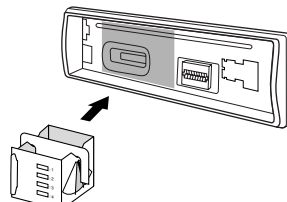

Measure this angle.
Mesurez cet angle.

1 Détachez le panneau de commande.

2 Mesurez l'angle.

- Fixez le gabarit de mesure dans une position proche et à plat de l'appareil (dans la partie en gris de l'illustration ci-dessus).

3 Notez l'angle mesuré.

- ① → ANGLE 1 (-5,0 à 17,0°)
- ② → ANGLE 2 (17,0 à 23,0°)
- ③ → ANGLE 3 (23,0 à 28,0°)
- ④ → ANGLE 4 (28,0 à 32,0°*)

* Il n'est pas recommandé d'installer l'appareil avec un angle de plus de 30°; sinon, cela peut entraîner un mauvais fonctionnement.

Quand vous utilisez l'autoradio pour la première fois après l'installation...

Suivez la procédure décrite aux pages 11 et 12 du MANUEL D'INSTRUCTIONS (volume séparé).

Connecting the GPS antenna

- People who use pacemakers should avoid a physical contact with the magnetic antenna and should not handle it themselves. This causes malfunctions of the pacemakers.
- Keep the magnetic antenna away from the storage media such as disks, credit cards; otherwise, its data will be collapsed.
- The antenna should be attached so firmly that it cannot be detached in the event of a collision or sudden braking.

A Inside the car / À l'intérieur de la voiture

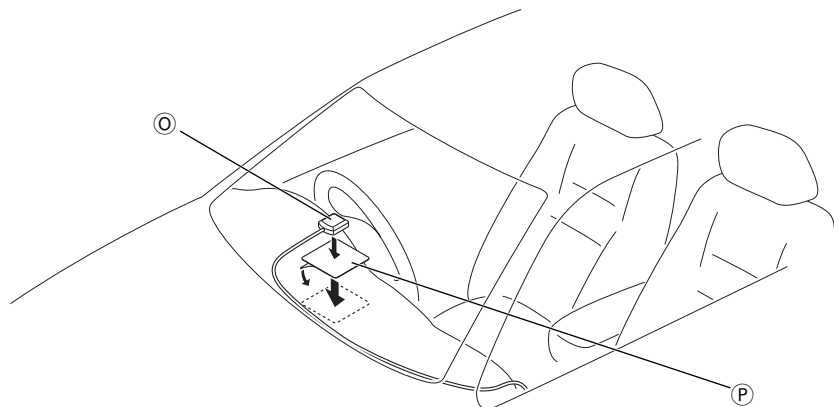

A Inside the car

Beneath a non-metallised* window, fix the attachment mat (P) on the dashboard, then place the antenna (O) on the mat.

- Make sure that the antenna is not covered by any components and parts of the car and it can receive the signals from all directions.

* The windows with screen antenna, windscreen heating or thermally insulated screens will interfere with GPS reception, and will degrade the reliability of the Navigation System.

B Outside the car

Fix the antenna (O) to a pre-washed, flat, metallic surface.

- Wire the antenna cord so as not to allow the rain to leak in.
- The antenna magnetically attached will be used even at a speed of 180 km/h (maximum). The antenna must be specially secured for higher speeds.
- Detach the antenna before you wash the car with the car-wash facilities.

Connexion de l'antenne GPS

- Les personnes utilisant un stimulateur cardiaque doivent éviter tout contact physique avec l'antenne magnétique et ne doivent pas la manipuler elles-mêmes. Cela pourrait entraîner un dysfonctionnement du stimulateur cardiaque.
- Tenez l'antenne magnétique à distance des supports de mémoire tels que les disques, les cartes de crédit; sinon, les données pourraient être corrompues.
- L'antenne doit être fixée suffisamment solidement pour qu'elle ne puisse pas se détacher en cas de choc ou de coup de frein brutal.

B Outside the car / À l'extérieur de la voiture

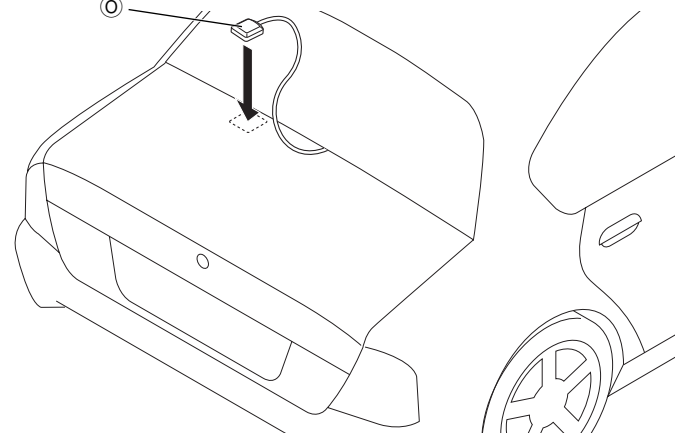

A À l'intérieur de la voiture

Derrière une fenêtre non métallisée*, fixez la feuille de fixation (P) sur le tableau de bord, puis placez l'antenne (O) sur la feuille.

- Assurez-vous que l'antenne n'est recouverte par aucun composant ou aucune partie de la voiture et peut recevoir les signaux de toutes les directions.

* Les vitres avec une antenne incrustée, les chauffages de pare-brise ou les écrans d'isolation thermique interfèrent avec la réception GPS et réduisent la fiabilité du système de navigation.

B À l'extérieur de la voiture

Fixez l'antenne (O) sur une surface métallique plate.

- Câblez le cordon d'antenne de façon à empêcher la pluie de pénétrer à l'intérieur.
- Une fois fixée, l'antenne magnétique ne se détachera pas même à une vitesse de 180 km/h (maximum). L'antenne doit être fixée spécialement pour les vitesses plus élevées.
- Détachez l'antenne avant de laver votre voiture dans un poste de lavage.

Required connections for DVD playback / Connexions requises pour la lecture de DVD

KV-MR9010

Wide color monitor (not supplied)
Moniteur couleur à écran large (non fourni)

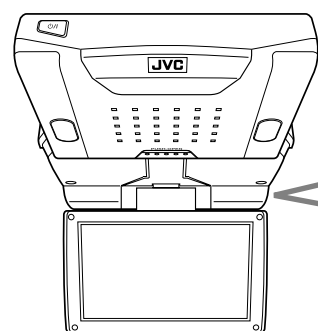

Amplifier or the decoder compatible with the multichannel digital sources
Amplificateur ou décodeur compatible avec les sources numériques à canaux multiples

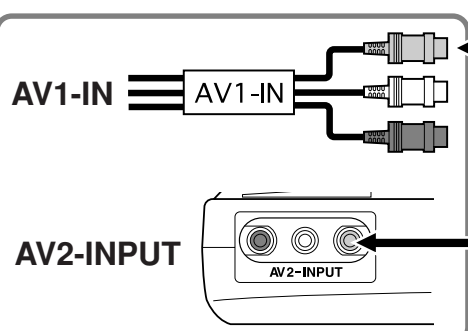

To Video input
À l'entrée vidéo

Video cord (not supplied)
Cordon vidéo (non fourni)

VIDEO OUT

Digital optical cable (not supplied)
Câble optique numérique (non fourni)

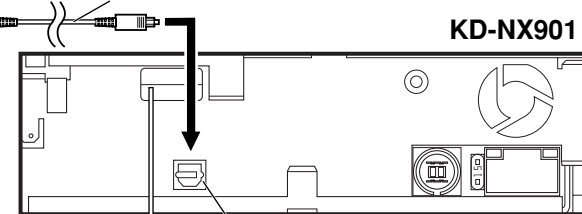

DIGITAL OUT

About sounds reproduced through the DIGITAL OUT terminal, see page 111 of the INSTRUCTIONS.

À propos des sons reproduits par la prise DIGITAL OUT, référez-vous à la page 111 du MANUEL D'INSTRUCTIONS.

ELECTRICAL CONNECTIONS

To prevent short circuits, we recommend that you disconnect the battery's negative terminal and make all electrical connections before installing the unit.

- Be sure to ground this unit to the car's chassis again after installation.

Notes:

- Replace the fuse with one of the specified rating. If the fuse blows frequently, consult your JVC IN-CAR ENTERTAINMENT dealer.
- It is recommended to connect to the speakers with maximum power of more than 50 W (both at the rear and at the front, with an impedance of 4 Ω to 8 Ω). If the maximum power is less than 50 W, change "Amp Gain" setting to prevent the speakers from being damaged (see page 89 of the INSTRUCTIONS).
- Incorrect wiring may result in damage to or destruction of vehicle components and safety devices.
- To prevent short-circuits and any associated risk of fire, cover the terminals of the UNUSED leads with insulating tape.
- The heat sink becomes very hot after use. Be careful not to touch it when removing this unit.

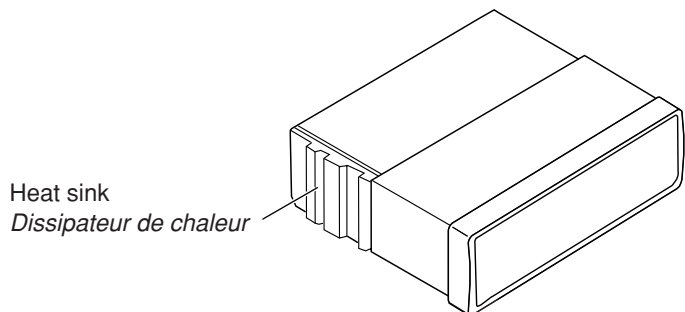

RACCORDEMENTS ÉLECTRIQUES

Pour éviter tout court-circuit, nous vous recommandons de débrancher la borne négative de la batterie et d'effectuer tous les raccordements électriques avant d'installer l'appareil.

- Assurez-vous de raccorder de nouveau la mise à la masse de cet appareil au châssis de la voiture après l'installation.

Remarques:

- Remplacer le fusible par un de la valeur précisée. Si le fusible saute souvent, consulter votre revendeur d'autoradios JVC.
- Il est recommandé de connecter des enceintes avec une puissance de plus de 50 W (les enceintes arrière et les enceintes avant, avec une impédance comprise entre 4 Ω et 8 Ω). Si la puissance maximum est inférieure à 50 W, changez "Amp Gain" pour éviter d'endommager vos enceintes (voir page 89 du MANUEL D'INSTRUCTIONS).
- Un câblage incorrect peut entraîner des dommages ou la destruction de composants du véhicule ou de dispositifs de sécurité.
- Pour éviter tout court-circuit et tout risque d'entraîner un incendie, recouvrez les extrémités des fils INUTILISÉS avec un ruban isolant.
- Le dissipateur de chaleur devient très chaud après usage. Faites attention de ne pas le toucher en retirant cet appareil.

PRECAUTIONS on power supply and speaker connections:

- DO NOT connect the speaker leads of the power cord to the car battery; otherwise, the unit will be seriously damaged.
- BEFORE connecting the speaker leads of the power cord to the speakers, check the speaker wiring in your car.

PRÉCAUTIONS sur l'alimentation et la connexion des enceintes:

- NE CONNECTEZ PAS les fils d'enceintes du cordon d'alimentation à la batterie; sinon, l'appareil serait sérieusement endommagé.
- AVANT de connecter les fils d'enceintes du cordon d'alimentation aux enceintes, vérifiez le câblage des enceintes de votre voiture.

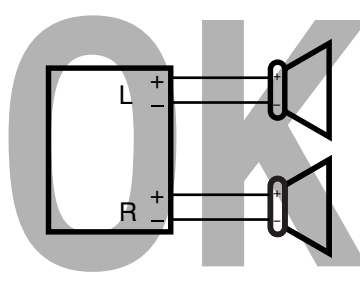
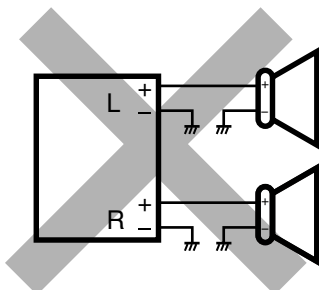
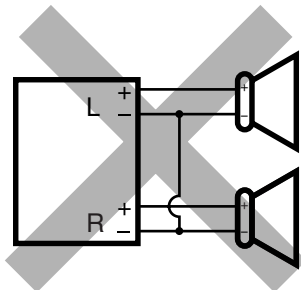

**A If your car is equipped with the ISO connector
Si votre voiture est équipée d'un connecteur ISO**

- Connect the ISO connectors as illustrated.
- Connectez les connecteurs ISO comme montré sur l'illustration.

View from the lead side
Vue à partir du côté des fils

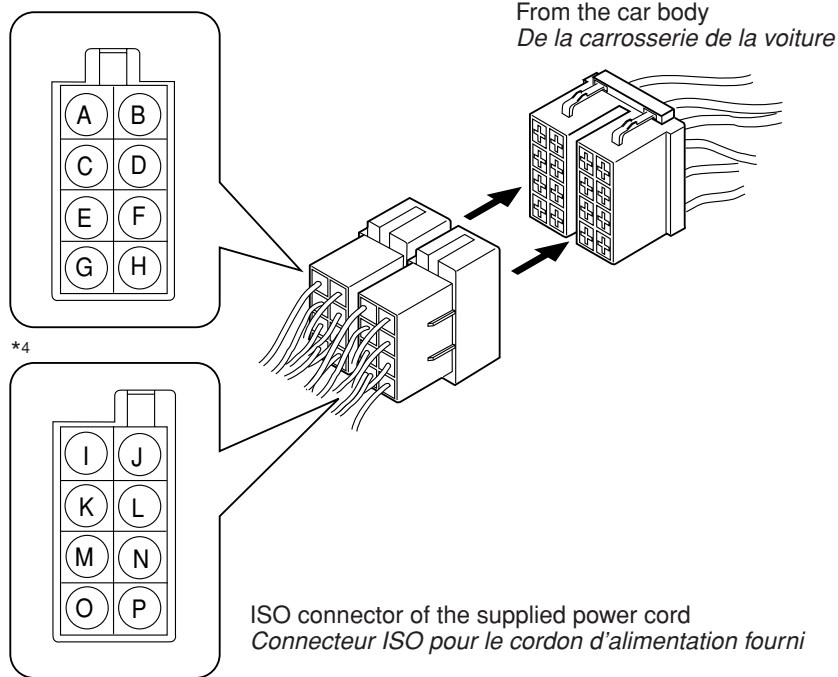

**For some VW/Audi or Opel (Vauxhall) automobile
Pour certaines voitures VW/Audi ou Opel (Vauxhall)**

You may need to modify the wiring of the supplied power cord as illustrated.

Vous aurez peut-être besoin de modifier le câblage du cordon d'alimentation fourni comme montré sur l'illustration.

- Contactez votre revendeur automobile autorisé avant d'installer l'appareil.

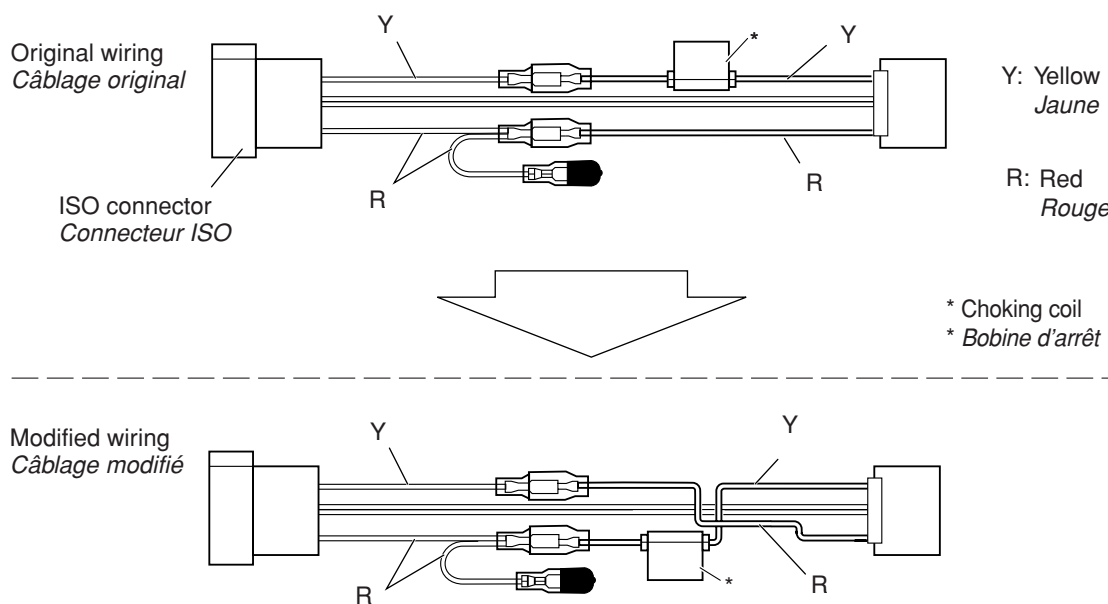

CAUTION: If no ACC position exists on the ignition switch, connect the red lead through the unit to a terminal which can be switched on and off by the ignition switch. Otherwise, it may cause the car battery to be exhausted.

ATTENTION: Si l'interrupteur d'allumage ne possède pas de position ACC, connectez le fil rouge provenant de l'appareil à une prise qui peut être mise sous et hors tension par l'interrupteur d'allumage. Sinon, la batterie de la voiture risquerait de se décharger.

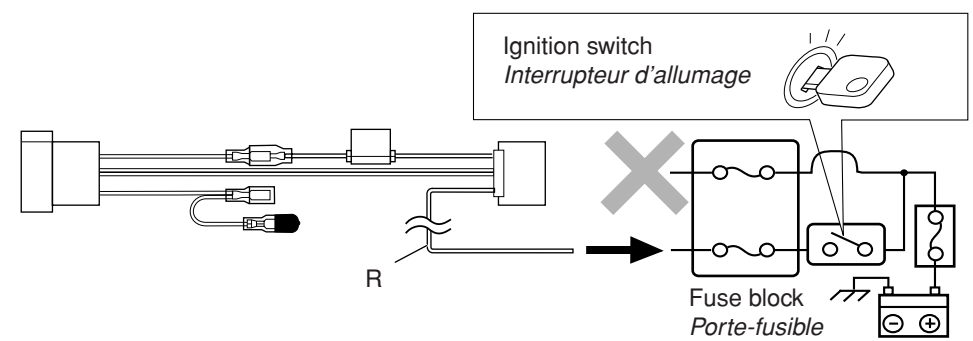

*4 The assignment of the ISO plug may vary among the cars. Incorrect wiring may result in damage to or destruction of car components and safety devices. If you are in any doubt, contact your vehicle manufacturer or authorised specialist workshop.

*4 L'affectation des fiches ISO peut varier selon la voiture. Un câblage incorrect peut entraîner des dommages ou la destruction de composants du véhicule ou de dispositifs de sécurité. Si vous avez des doutes, contactez le fabricant de votre voiture ou un magasin spécialisé autorisé.

Connections without using the ISO connectors

Before connecting: Check the wiring in the vehicle carefully. Incorrect connection may cause serious damage to this unit.

The leads of the power cord and those of the connector from the car body may be different in color.

- 1 Cut the ISO connector.
- 2 Connect the colored leads of the power cord in the order specified in the illustration below.
- 3 Connect the aerial cord and GPS antenna.
- 4 Finally connect the wiring harness to the unit.

Connexions sans l'utilisation des connecteurs ISO

Avant de commencer la connexion: Vérifiez attentivement le câblage du véhicule. Une connexion incorrecte peut endommager sérieusement l'appareil.

Le fil du cordon d'alimentation et ceux des connecteurs du châssis de la voiture peuvent être différents en couleur.

- 1 Coupez le connecteur ISO.
- 2 Connectez les fils colorés du cordon d'alimentation dans l'ordre spécifié sur l'illustration ci-dessous.
- 3 Connectez le cordon d'antenne et l'antenne GPS.
- 4 Finalement, connectez le faisceau de fils à l'appareil.

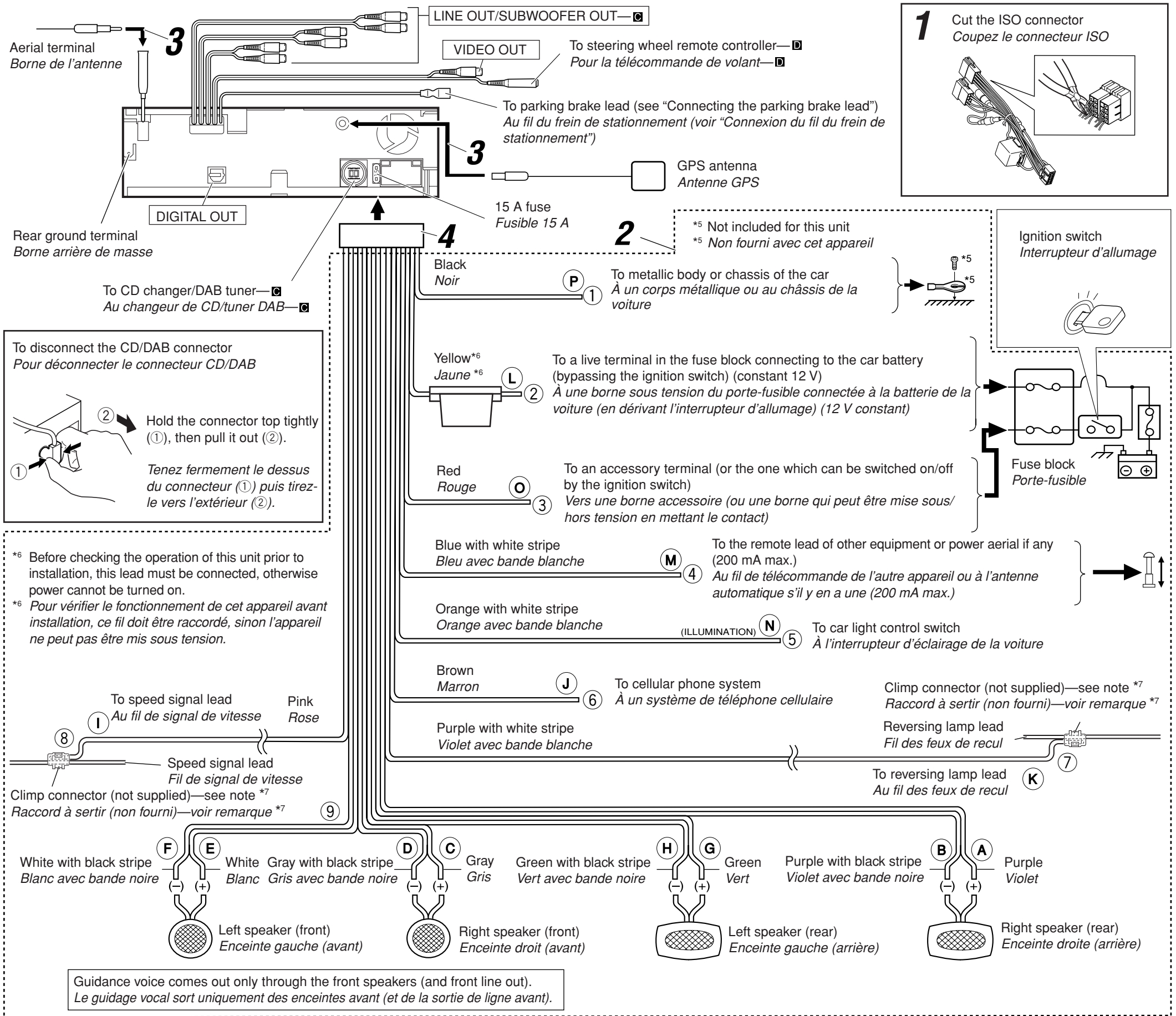

Connecting the speed signal lead (①)

Locate the signal lead from the speedometer, then connect it and the speed signal lead from the power cord with a climp connector (not supplied).

- If you do not know the exact installation position/location of the speed signal lead, consult the vehicle manufacturer or your car dealer. Incorrect wiring may damage or destruct the vehicle components and safety devices.
- This connection is necessary to use the Navigation System.

Connexion du fil de signal de vitesse (①)

Localisez le fil provenant de l'indicateur de vitesse, puis connectez-le au fil de signal de vitesse provenant du cordon d'alimentation en utilisant un raccord à sertir (non fourni).

- Si vous ne connaissez pas la position d'installation ou l'emplacement exact du fil de signal de vitesse, consultez le fabricant du véhicule ou votre revendeur automobile. Un câblage incorrect peut endommager ou détruire les composants et dispositifs de sécurité du véhicule.
- Cette connexion est nécessaire pour pouvoir utiliser le système de navigation.

Connecting the reverse gear signal lead (Ⓚ)

Locate the reversing lamp lead in the boot, then connect it and the reverse gear signal lead from the power cord with a climp connector (not supplied).

- This connection is necessary to locate car position precisely for navigation by detecting the car movement—forward/backward.

Connexion du fil de signal de marche arrière (Ⓚ)

Localisez le fil des feux de recul dans le coffre, puis connectez le fil de signal de marche arrière provenant du cordon d'alimentation en utilisant un raccord à sertir (non fourni).

- Cette connexion est nécessaire pour la navigation afin de localiser la position de la voiture avec précision en détectant les mouvements avant/arrière de la voiture.

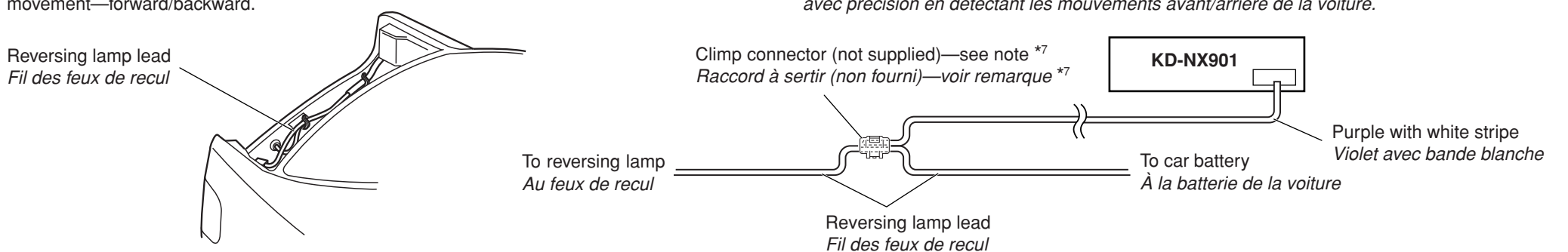

Connecting the parking brake lead using the supplied crimp connector (J) and parking brake extension lead (K)

Connexion du fil du frein de stationnement en utilisant un raccord à sertir (J) et le cordon prolongateur du frein de stationnement (K)

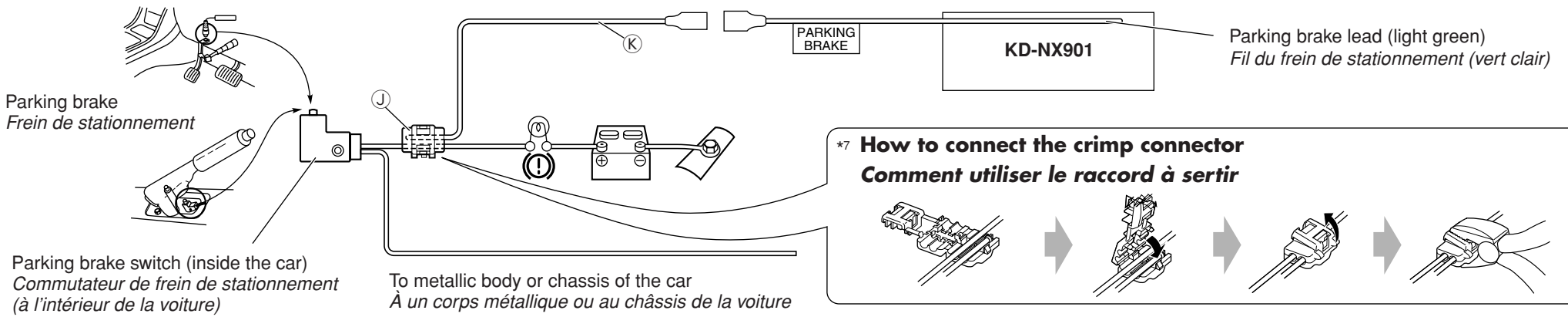

C Connections Adding Other Equipment
Raccordement pour ajouter d'autres appareils

LINE OUT—Amplifier / Amplificateur

You can connect an amplifier and other equipment to upgrade your car stereo system.

- Connect the remote lead (blue with white stripe) to the remote lead of the other equipment so that it can be controlled through this unit.
- For amplifier only:
 - **Disconnect the speakers from this unit, connect them to the amplifier. Leave the speaker leads of this unit unused.**
 - Guidance voice comes out only through the front line out.

Vous pouvez connecter un amplificateur ou autre appareil pour améliorer votre système autoradio.

- Connectez le fil de commande à distance (bleu avec bande blanche) au fil de commande à distance de l'autre appareil de façon qu'il puisse être commandé via cet appareil.
- Pour l'amplificateur seulement:
 - **Déconnectez les enceintes de cet appareil et connectez-les à l'amplificateur. Laissez les fils d'enceintes de cet appareil inutilisés.**
 - Le guidage vocal sort uniquement de la sortie de ligne avant.

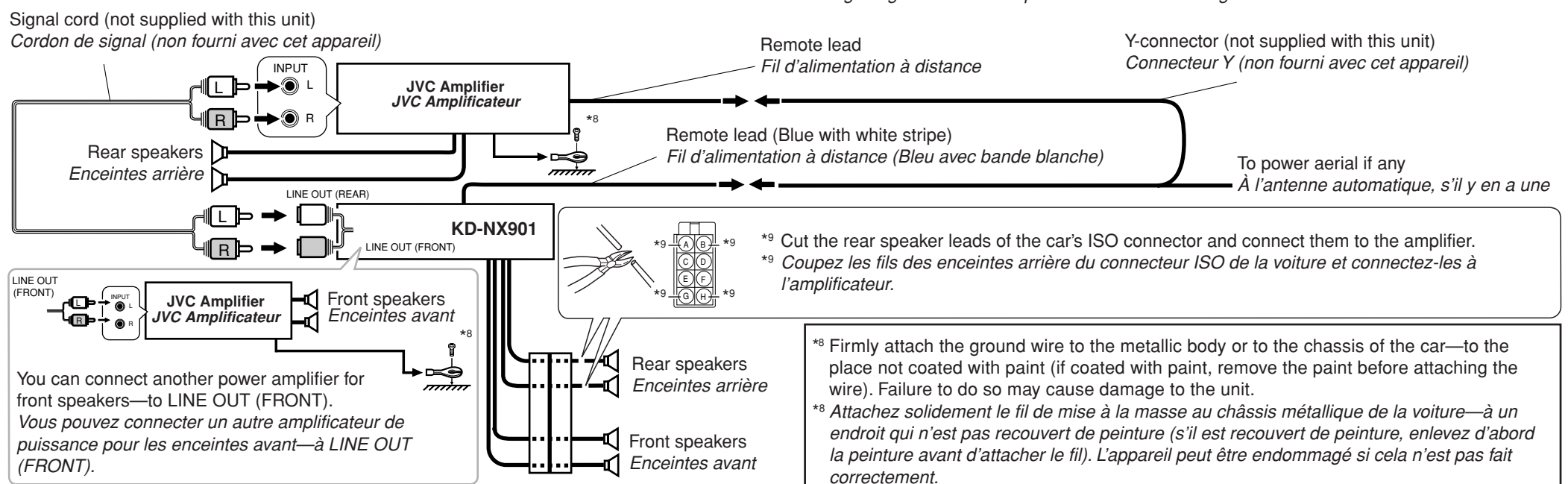

CD changer and DAB tuner / Changeur de CD et tuner DAB

Refer also to pages 93 and 99 of the INSTRUCTIONS.
Référez-vous aux pages 93 et 99 du MANUEL D'INSTRUCTIONS.

CAUTION:
Before connecting the CD changer and/or the DAB tuner, make sure that the unit is turned off.

PRÉCAUTION:
Avant de connecter le changeur de CD et/ou le tuner DAB, s'assurer que l'unité est éteinte.

Connecting cord supplied with your DAB tuner
Cordon de connexion fourni avec votre tuner DAB

Connecting cord supplied with your CD changer
Cordon de connexion fourni avec votre changeur de CD

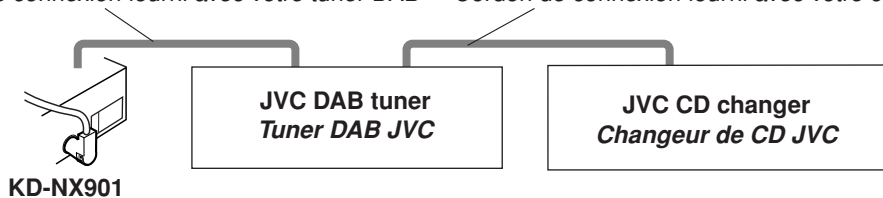

- You can connect both components in series as illustrated above.
- Vous pouvez connecter les deux appareils en série comme montré ci-dessus.

Connecting cord supplied with your DAB tuner or CD changer
Cordon de connexion fourni avec votre tuner DAB ou changeur de CD

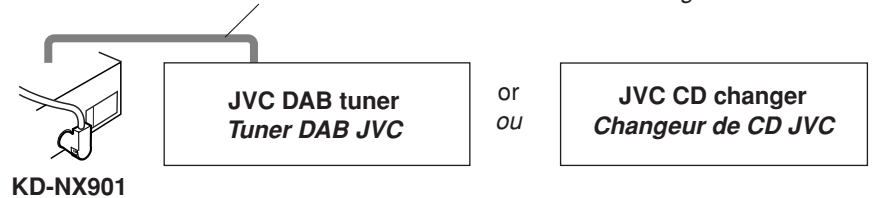

External Component / Appareil extérieur

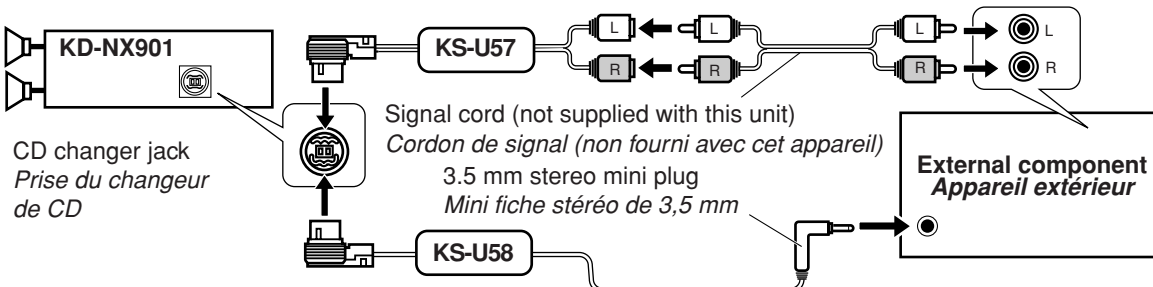

KS-U57 : Line Input Adapter—optionally purchased
: Adaptateur d'entrée de ligne—vendu séparément

KS-U58 : Aux Input Adapter—optionally purchased
: Adaptateur d'entrée auxiliaire—vendu séparément

SUBWOOFER OUT

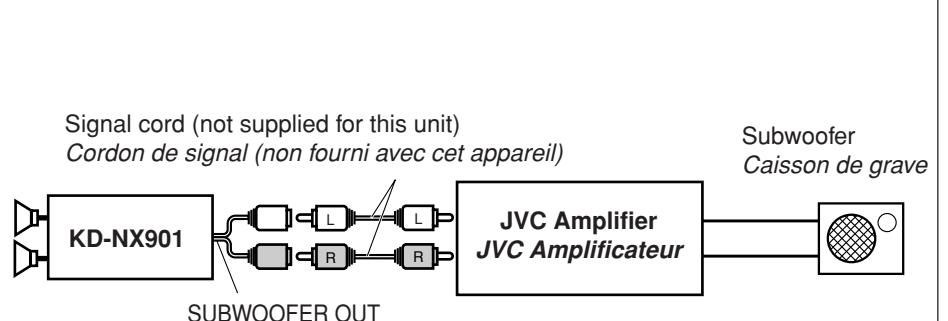

D Connecting to the steering wheel remote controller
Connexion de la télécommande de volant

If your car is equipped with the steering wheel remote controller, you can operate this receiver using the controller. To do it, a JVC's OE remote adapter (not supplied) which matches with your car is required. Consult your JVC IN-CAR ENTERTAINMENT dealer for details.

Si votre voiture est munie d'une télécommande de volant, vous pouvez commander cet autoradio en utilisant la télécommande. Pour le faire, un adaptateur pour télécommande au volant JVC (non fourni) correspondant à votre voiture est nécessaire. Consultez votre revendeur d'autoradio JVC pour les détails.

